



EUROMAG
INTERNATIONAL



Hand Held Ultrasonic Flow Meter
EUROSONIC 2000 HH

TD 204-0-ENG 

User Manual

READ AND KEEP THESE INSTRUCTIONS



1. INTRODUCTION	7
1.1 Preface	7
1.2 Features	7
1.3 Flow measurement principle	8
1.4 Part identification	9
1.5 Typical applications	10
1.6 Data integrity and built in time keeper	10
1.7 Product identification	10
1.8 Specifications	11
2. MEASUREMENT	13
2.1 Built in battery	13
2.2 Power on	13
2.3 Keypad	14
2.4 Menu windows	14
2.5 Menu window list	15
2.6 Steps to configure parameters	16
2.7 Transducer mounting allocation	17
2.8 Transducer installation	18
2.8.1 Transducer Spacing	19
2.8.2 V Method Installation	19
2.8.3 Z Method Installation	20
2.8.4 W Method Installation	20
2.9 Installation testing	20
2.9.1 Signal Strength	20
2.9.2 Signal Quality	21
2.9.3 Total Transit Time and Delta Time	21
2.9.4 Transit Time Ratio	21

3. HOW TO CHECK AND SETUP**23**

3.1	How to check the instrument works properly	23
3.2	How to check the liquid flow direction	23
3.3	How to change the unit readings	23
3.4	How to select a flow rate	23
3.5	How to use the totalizer multiplier	23
3.6	How to set the totalizer functions	24
3.7	How to reset totalizers	24
3.8	How to restore the factory defaults	24
3.9	How to use the damper to stabilise the flow rate	24
3.10	How use the zero cut off function	24
3.11	How to set a zero point	24
3.12	How to change the flow rate scale factor	24
3.13	How to set and lock the password	24
3.14	How to use the inbuilt data logger	25
3.15	How to use the frequency output	25
3.16	How to use the totalizer pulse output	25
3.17	How to produce an alarm signal	26
3.18	How to use the built in buzzer	26
3.19	How to use the oct pulse output	26
3.20	How to set the built in calender	26
3.21	How to adjust the lcd contrast	26
3.22	How to use the rs232 serial interface	27
3.23	How to view the totalizers	27
3.24	How to use the working timer	27
3.25	How to use the manual totalizer	27
3.26	How to check the serial number	27
3.27	How to check the battery life	27
3.28	How to charge the battery	27

4. MENU WINDOW DETAILS**29****5. TROUBLE SHOOTING****35**

5.1	Power-on errors	35
5.2	Working status errors	35
5.3	Other problems and solutions	37

6. COMMUNICATION PROTOCOL **39**

6.1	Rs232 connector pin-out	39
6.2	Communication protocol	39
6.2.1	Basic Commands	39
6.2.2	Protocol Prefix Usage	41
6.3	The m command and the ascii codes	42

7. WARRANTY AND SERVICE **43**

7.1	Warranty	43
7.2	Service	43

8. APPENDIX **45**

8.1	Battery maintenance and replacement	45
8.2	Pipe size tables	45
8.2.1	Standard Pipe size charts for Copper	45
8.2.2	Standard Pipe size charts for PVC	48
8.2.3	Standard Pipe size charts for Steel pipe	49
8.2.4	Standard Pipe size charts for Cast Iron Pipe	56
8.2.5	Standard Pipe size charts for Ductile Iron Pipe	57
8.3	Sound speed tables	58
8.3.1	Sound Speed data of solids	58
8.3.2	Sound Speed in Water	60
8.3.3	Sound Speed in Liquids	61

List of figures

Figure 1:	transit time flow measurement principle	8
Figure 2:	top panel and front view	9
Figure 3:	transducers and cables	9
Figure 4:	keypad	14
Figure 5:	pipe configuration and transducer placement	18
Figure 6:	transducer clamp down	19
Figure 7:	transducer v method mounting	20
Figure 8:	transducer z method mounting	20
Figure 9:	transducer w method mounting	20
Figure 10:	rs232 wiring diagram	39

1. INTRODUCTION

1.1 PREFACE

The hand held flow meter is a battery-powered ultrasonic flow meter with the capability of regular full-size instrument. It is carefully designed for portability and ease of use.

The hand held flow meter is based on clamp-on transit-time flow measurement principle. It measures the flow rate of liquid in a pipe from outside the pipe by using a pair of ultrasonic transducers. In general, the liquid should fill up the pipe, and should contain very little particles or bubbles. Examples of applicable liquids are: water (hot water, chill water, city water, sea water, etc.); sewage; oil (crude oil, lubricating oil, diesel oil, fuel oil, etc.); chemicals (alcohol, acids, etc.); waste; beverage and liquid food, solvents and other liquids.

Due to the clamp-on technique nature, the transducer installation is simple and no special skills or tools are required. Besides, there is no pressure drop, no moving parts, no leaks and no process contamination. The hand held flow meter utilizes our proprietary technologies such as advanced signal processing, low-voltage transmitting, small signal receiving with self-adapting, etc. It also incorporates the latest surface-mounting semiconductors and mini PCB design techniques. The built-in rechargeable Ni-MH battery can work continuously for more than 10 hours without recharge.

The hand held flow meter has also a built-in data-logger, which allows the storage of 2,000 lines of data. The stored information can be downloaded to a PC through its RS232 connection port. The hand held flow meter also provides digital output such as frequency output or pulsed totalizer output.

1.2 FEATURES

- $\pm 0.5\%$ of linearity
- $\pm 0.2\%$ of repeatability
- $\pm 1\%$ of accuracy at velocity above 0.6ft/s.
- $\pm 0.5\%$ when on-site calibration is available
- Bi-directional measurement
- 4 flow totalizers
- Proprietary low-voltage transmission technology
- Wide pipe size range
- 100 Pico-second time measurement resolution
- 0.5 second totalizing period
- Built-in data-logger
- Clam-on transducer. Easy to install and to maintain
- Light weight, portable. Main unit 1.2lbs.
- Also able to be used for long-term deployment

1.3 FLOW MEASUREMENT PRINCIPLE

The hand held flow meter ultrasonic flow meter is designed to measure the velocity of liquid within a closed conduit. It uses the well-know transit-time technology. The transducers are a non-contacting, clamp-on type. They do not block the flow, thus no pressure drop. They are easy to install and remove.

The hand held flow meter utilizes a pair of transducers that work as both ultrasonic transmitter and receiver. The transducers are clamped on the outside of a closed pipe at a specific distance one from each other. The transducers can be mounted in V-method where the sound transverses the pipe twice, or W-method where the sound transverses the pipe four times, or in Z-method where the transducers are mounted on opposite sides of the pipe and the sound crosses the pipe once. The selection of the mounting methods depends on pipe and liquid characteristics.

The hand held flow meter operates by alternately transmitting and receiving a frequency-modulated burst of sound energy between the two transducers and measuring the transit time that it takes for sound to travel between the two transducers. The difference in the transit time measured is directly and exactly related to the liquid speed, as shown in the following figure.

TRANSIT TIME FLOW MEASUREMENT PRINCIPLE

$$V = \frac{MD}{\sin 2\theta} \times \frac{\Delta T}{T_{up} \cdot T_{down}}$$

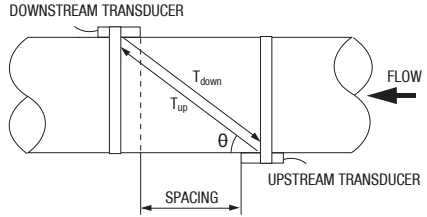

f. 1

REFERENCES

- θ is the angle between the sound path and the flow direction
- M is the number of times the sound transverses the flow
- D is the pipe diameter
- T_{up} is the time for the beam travelling from upstream the transducer to the downstream transducer
- T_{down} is the time for the beam travelling from the downstream transducer to the upstream transducer
- $\Delta T = T_{up} - T_{down}$

1.4 PART IDENTIFICATION

TOP PANEL AND FRONT VIEW

Top View

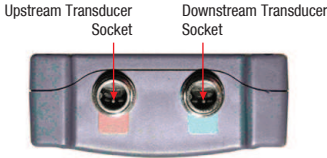

Front View



Bottom View

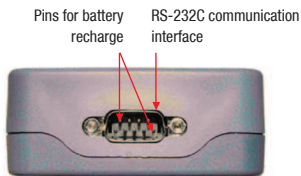

TRANSDUCERS AND CABLES

S1-Type

(1/4"-28") 15-100mm



M1-Type

(2"-28") 40-700mm



L1-Type

(1 1/2"-240") 300-6000mm



Cable 5 metre X 2

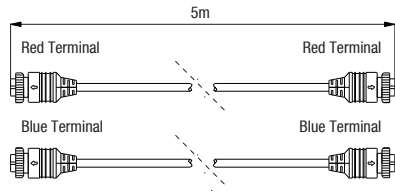

Converter Terminal and AC adapter

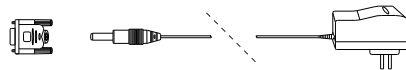

Cable Rs232 Interface

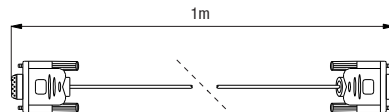

1.5 TYPICAL APPLICATIONS

The Eurosonic 2000 HH hand held flow meter can be applied to a wide range of pipe flow measurements. The pipe size ranges 0.5”-240” (15mm-6000mm). A variety of liquid applications can be accommodated: ultra-pure liquids, potable water, oil, chemicals, raw sewage, reclaimed water, cooling water, river water, sea water, plant effluent, etc. Because the transducers are non-contacting and have no moving parts, the flow meter will not be affected by flow pressure or liquid properties. Standard transducers are rated to 100°C. Higher temperatures can be accommodated. For further information, please consult the manufacturer for assistance.

or ESN written into the software that can only be modified with a special tool by the manufacturer. In case of any hardware failure, please provide this number which is located on menu window M61 when contacting the manufacturer.

1.6 DATA INTEGRITY AND BUILT IN TIME KEEPER

All user-entered configuration values are stored in the built-in non-volatile flash memory that can retain the data for over 100 years, even when the power is lost or turned off. Password protection is provided to avoid inadvertent configuration changes or totalizer resets.

A time-keeper is integrated in the flow meter. It works as the time base for flow totalizing. The time-keeper remains operating as long as the battery’s terminal voltage is over 1.5V. In case of battery failure, the time-keeper will not keep running and the time data will be lost. The user must re-enter proper time values after the battery failure is recovered. Improper time values will affect the totalizers as well as many other functions.

1.7 PRODUCT IDENTIFICATION

Each set of the hand held flow meter series flow meter has a unique product identification number

1.8 SPECIFICATIONS

Hand Set	
Linearity	0.5%
Repeatability	0.2%
Accuracy	$\pm 1\%$ of reading at rates > 0.6 ft/s. $\pm 0.5\%$ with on-site calibration
Response Time	0-999 seconds, user-configurable
Velocity	$\pm 0.03 \sim \pm 105$ ft/s ($\pm 0.01 \sim \pm 30$ m/s), bi-directional
Pipe Size	0.5" ~ 240" (15 ~ 6,000mm)
Rate Units	Meter, Feet, Cubic Meter, Liter, Cubic Feet, USA Gallon, Imperial Gallon, Oil Barrel, USA Liquid Barrel, Imperial Liquid Barrel, Million USA Gallons. User configurable.
Totalizer	7-digit totals for net, positive and negative flow
Liquid Types	Virtually all liquids
Security	Setup lockout. Access code needed for unlocking
Display	4x16 characters
Communication Interface	RS-232C, baud-rate: from 75 to 115,200 bps. Protocol made by the manufacturer. User protocols can be made on enquiry.
Transducers	Model EST-M1 for standard, other 2 models optional
Transducer Cable	Standard 2x15' (5m), optional 2x1,500' (500m)
Power Supply	3 AAA Ni-MH built-in batteries. When fully charged it will last over 10 hours of operation. 100V-240VAC for the charger
Data Logger	Built-in data logger can store over 2,000 lines of data
Manual Totalizer	7-digit press-key-to-go totalizer for calibration
Housing Material	ABS. Aluminum alloy protective case
Case Size	3.9"x2.6"x0.8" (100x66x20mm)
Handset Weight	1.2 lbs (514g) with batteries

2. MEASUREMENT

2.1 BUILT IN BATTERY

The instrument can operate either from the built-in Ni-MH rechargeable battery, which will last over 10 hours of continuous operation when fully charged, or from an external AC/power supply from the battery charger.

The battery charging circuit deliver both constant-current and constant-voltage charging methods. It has a characteristic of fast charging at the beginning and very slow charging when the battery approaches to full charge. Generally, when the green LED is on, the battery is nearly 95% charged, and when the red LED is off, the battery is nearly 98% charged.

The charging current becomes automatically smaller and smaller when approaching the full battery level, so that there should be no over-charging problem. This also means that the charging progress can last very long. The charger can be connected to the handset all the time when an around-the-clock measurement is required.

When fully charged, the terminal voltage reaches about 4.25V. The terminal voltage is displayed on window M07. When running out of battery, its voltage drops below 3V. The approximate remaining working time is indicated in this window as well.

Notice that the battery remaining working time is estimated based on the current battery voltage. It may have some errors, especially when the terminal voltage is in the range from 3.70 to -3.90 volts.

For Battery maintenance and replacement, please refer to *Appendix A*.

2.2 POWER ON

Press  key to turn on the device and press  to turn it off.

Once the flow meter is turned on, it will run a self-diagnostic program, checking first the hardware and then the software integrity. If there is any anomaly, corresponding error messages will be displayed.

Generally, there should be no display of error messages, and the flow meter will go to the most commonly used Menu Window #01 (short for M01) to display the Velocity, Flow Rate, Positive Totalizer, Signal Strength and Signal Quality, based on the pipe parameters configured last time by the user or by the factory.

The flow measurement program always operates in the background of the user interface. This means that the flow measurement will keep on running regardless of any user menu window browsing or viewing. Only when the user enters new pipe parameters the flow meter will change measurement to reflect the new parameter changes.

When new pipe parameters are entered or when the power is turned on, the flow meter will enter into a self-adjusting mode to adjust the gain of the receiving circuits so that the signal strength will stay within a proper range. By this step, the flow meter finds the best receiving signals. The user will see the progress by the number 1, 2, or 3, located on the lower right corner of the LCD display.

When the user adjusts the position of the installed transducers, the flow meter will re-adjust the signal gain automatically.

Any user-entered configuration value will be stored in the NVRAM (non-volatile memory), until it is modified by the user.

2.3 KEYPAD

The keypad of the flow meter has 16+2 keys.



Keys 0 ~ 9 and . are keys to enter numbers.

Key (▲/+) is the going UP key when the user wants to go to the upper menu window. It also works as '+' key when entering numbers.

Key (▼/-) is the going DOWN key when the user wants to go to the lower menu window. It also works as the '-' key when entering numbers.

Key (◀) is the backspace key when the user wants go left or wants to backspace the left character that is located to the left of the cursor.

Key (ENT) is the ENTER key for any input or selections.

Key (MENU) is the key for the direct menu window jump over. Whenever the user wants to proceed to a certain menu window, the user can press this key followed by a 2-digit number.

The (MENU) key is shortened as the 'M' key hereafter when referring to menu windows.

The (ON) key is for the power on.

The (OFF) key is for the power off.

2.4 MENU WINDOWS

The user interface of this flow meter comprises about 100 different menu windows that are numbered by M00, M01, M02 ... M99.

There are two methods to get into certain menu window:

1) Direct jump in. The user can press the (MENU) key followed by a 2-digit number. For example, the menu window M11 is for setting up pipe outer diameter.

Pressing **MENU** **1** **1** will display the M11 menu window immediately.

2) Press **▲/▶** or **▼/◀** key. Pressing the **▲/▶** will show to the user the lower-numbered menu window. For example, if the current window is on M12, the display will go to window M11 after the **▲/▶** key is pressed once.

There are three different types of menu windows:

- 1) Menu windows for number entering, e.g., M11 for setting up pipe outer diameter.
- 2) Menu windows for option selection, e.g., M14 for the selection of pipe materials.
- 3) Results display windows, e.g., window M00 for displaying Velocity, Flow Rate, etc.

For number entering windows, the user can directly press the digit keys if the user wants to modify the value. For example, if the current window is on M11, and the user wants to enter 219.2345 as the pipe outer diameter, then, the following keys should be pressed: **2** **1** **9** **.** **2** **3** **4** **5** **ENT**.

For option selection windows, the user should first press the **ENT** key to get into option selection mode. Then, use **▲/▶**, **▼/◀**, or digit key to select the right option. Consequently, press the **ENT** to make the selection.

For example, assume your pipe material is stainless steel and you are currently on menu window M14 which is for the selection of pipe materials (if you are on a different window, you need press **MENU** **1** **4** first in order to enter into the M14 window.) You need to press the **ENT** key to get into the option selection mode. Then, either press the **▲/▶** and **▼/◀** keys to make the cursor on the line that displays “1. Stainless Steel”, or press the **1** key directly. At the end, press **ENT** again to make the selection.

Generally, the **ENT** key must be pressed to get into

the option selection mode for option modifications. If the “Locked M47 Open” message is indicated on the lowest line of the LCD display, it means that the modification operation is locked out. In such cases, the user should go to M47 to have the instrument unlocked before any further modification can be made.

2.5 MENU WINDOW LIST

M00~M09 windows are suitable for viewing the instantaneous flow rate, net totalizer value, positive totalizer value, negative totalizer value, instantaneous flow velocity, date time, battery voltage and estimated working hours for the battery.

M10~M29 windows have to be used for entering system parameters, such as pipe outer diameter, pipe wall thickness, liquid type, transducer type / model, transducer installation method, etc. Transducer installation spacing is also displayed on one of the windows.

M30~M38 windows allow the user to enter the flow rate unit and to configure the totalizer. User can use these windows to select flow rate unit, such as cubic meter or litre, as well as to turn on / off each totalizer, or to zero the totalizers.

M40~M49 windows are for setting response time, zeroing / calibrating the system and changing password.

M50~M53 windows are for setting up the built-in logger.

M60~M78 windows are for setting up time-keeper and displaying software version, system serial number ESN and alarms.

M82 window is for viewing the totalizer.

M86~M89 windows are useful to configure some parameters about the signal management, such as automatic control, power selection and receive window width.

M90~M94 windows are for displaying diagnostic data. Those data are very useful when doing a more accurate measurement.

M97~M99 are not setup windows but commands for window copy output and pipe parameters output.

M+0~M+8 windows offer some additional functions, including a scientific calculator, display of the total working time, and display of the time and the flow rate when the device is turned on and turned off.

Other menu windows such as M88 have no functions, or functions were cancelled because they are not applied to this version of the software.

The major reason why the menu windows are arranged in this way is to make this version compatible with the previous ones. This will make things easier for a user that wants to switch from a previous version to the new one.

2.6 STEPS TO CONFIGURE THE PARAMETERS



















In order to make the hand held flow meter work properly, the user must follow the following steps to configure the system parameters:

1. Pipe size and pipe wall thickness
2. For standard pipe, please refer to *Appendix B* for outer diameter and wall thickness data. For non-standard pipe, the user has to measure these two parameters.
3. Pipe materials
For non-standard pipe material, the sound speed

of the material must be entered. Please refer to *Appendix C* for sound speed data.

4. For standard pipe materials and standard liquids, the sound speed values have already been programmed into the flow meter, therefore there is no need to enter them again.
5. Liner material, its sound speed and liner thickness, if there is any liner.
6. Liquid type (for non-standard liquid, the sound speed of the liquid should be entered.)
7. Transducer type.
8. Transducer mounting methods (the V-method and Z-method are the common methods)
9. Check the transducer distance displayed on window M25 and install the transducers accordingly.

Example: For standard (commonly used) pipe materials and standard (commonly measured) liquids, the parameter configuration steps are as following:

- 1) Press keys    to enter into M11 window. Input the pipe outer diameter through the keypad and press  key.
- 2) Press key  to enter into M12 window. Input the pipe thickness through the keypad and press  key.
- 3) Press key  to enter into M14 window. Press  key to get into the option selection mode. Use keys  and  to scroll up and down to the proper pipe material, and then press  key.
- 4) Press key  to enter into M16 window. Press  key to get into the option selection mode. Use keys  and  to scroll up and down to the proper liner material, and then press  key. Select "No Liner", if there is no liner.
- 5) Press key  to enter into M20 window. Press  key to get into the option selection mode. Use

keys \uparrow/\downarrow and \leftarrow/\rightarrow to scroll up and down to the proper liquid, and then press ENT key.

6) Press key \leftarrow/\rightarrow to enter into M23 window. Press ENT key to get into the option selection mode. Use keys \uparrow/\downarrow and \leftarrow/\rightarrow to scroll up and down to the proper transducer type, and then press ENT key.

7) Press key \leftarrow/\rightarrow to enter into M24 window. Press ENT key to get into the option selection mode. Use keys \uparrow/\downarrow and \leftarrow/\rightarrow to scroll up and down to the proper transducer mounting method, and then press ENT key.

8) Press key \leftarrow/\rightarrow to enter into M25 window. The transducer installation distance will be displayed on the window. Based on this distance, install the transducers on the pipe now. After installation is completed, press ENT key to go to M01 window to check if the measurement result is good.

The first-time users may need some time to get familiar with the operation. However, the user friendly interface of the instrument makes the operation quite easy and simple. You will soon find that it is actually very quick to configure the instrument with very little key pressing, since the interface allows the user to go to the desired operation directly without any extra steps.

The following tips will facilitate the operation of this instrument.

1) When the current window is one between M00 to M09, pressing a number key x will enter into the M0x window directly. For example, if the current window display is M01, pressing 7 leads to window M07.

2) When the current window is one between M00 to M09, pressing ENT key will lead to window M90 for

displaying diagnostic data. Press ENT key again to return to the previous window. Press the \leftarrow key to go to window M11.

When the current window is M25, pressing ENT key will lead to window M01.

2.7 TRANSDUCER MOUNTING ALLOCATION

The first step in the installation process is to select an optimal location for installing the transducers in order to make the measurement reliable and accurate. A basic knowledge about the piping and its plumbing system would be advisable.

An optimal location would be defined as a long straight pipe line full of liquid that is to be measured. The piping can be in vertical or horizontal position. The following table shows examples of optimal locations.

Principles to select an optimal location:

1. The straight pipe should be long enough to eliminate irregular-flow-induced error. Typically, the length of the straight pipe should be 15 times of the pipe diameter. The longer the better. The transducers should be installed at a pipe section where the length of the straight pipe at upstream side is at least 10D and at downstream side is at least 5D. Besides, the transducer installation site should be at least 30D away from the pump. Here D stands for pipe outer diameter. Refer to the following table for more details.

2. Make sure that the pipe is completely full of liquid.

3. Make sure that the temperature on the location does not exceed the range for the transducers. Generally speaking, the closer to the room temperature, the better.

4. Select a relatively new straight pipe line if it is

possible. Old pipe tends to have corrosions and depositions, which could affect the results. If you have to work on an old pipe, we recommend you to treat the corrosions and depositions as if they are part of the pipe wall or as part of the liner. For example, you can add an extra value to the pipe wall thickness parameter or the liner thickness parameter to take into account the deposition.

5. Some pipes may have a kind of plastic liner which creates a certain amount of gaps between liner and the inner pipe wall. These gaps could prevent ultrasonic waves from direct travelling. Such conditions will make the measurement very difficult. Whenever possible, try to avoid this kind of pipes. If you have to work on this kind of pipe, try our plug-in transducers that are installed permanently on the pipe by drilling holes on the pipe while liquid is running inside.

PIPE CONFIGURATION AND TRANSDUCER PLACEMENT

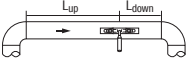
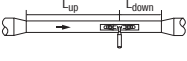
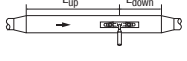
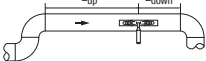
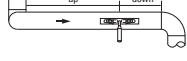
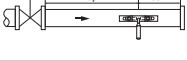
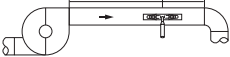
PIPING CONFIGURATION AND TRANSDUCER POSITION	UPSTREAM DIMENSION	DOWNSTREAM DIMENSION
	L_{up} X Diameters	L_{down} X Diameters
	10D	5D
	10D	5D
	10D	5D
	12D	5D
	20D	5D
	20D	5D
	30D	5D

f. 5

2.8 TRANSDUCER INSTALLATION

The transducers used by the ultrasonic flow meter are made of piezoelectric crystals both for transmitting and receiving ultrasonic signals through the wall of liquid piping system. The measurement is realized by measuring the travelling time difference of the ultrasonic signals. Since the difference is very small, the spacing and the alignment of the transducers are critical factors to the accuracy of the measurement and the performance of the system. Meticulous care should be taken for the installation of the transducers.

Steps to the installation of the transducers:

Locate an optimal position where the straight pipe length is sufficient (see the previous section), and where pipes are in a favourable condition, e.g., newer pipes with no rust and ease of operation.

Clean any dust and rust on the spot where the transducers are to be installed. For a better result, polishing the pipe outer surface with a sander is strongly recommended.

Apply adequate ultrasonic couplant (grease, gel or Vaseline)* on to the transducer transmitting surface as well as to the installation spot on the pipe surface. Make sure there is no gap between the transducer transmitting surface and the pipe surface.

Extra care should be taken to avoid any sand or dust particles left between the pipe surface and the transducer surface.

Horizontally lined pipes could have gas bubbles inside the upper part of the pipe. Therefore, it is recommended to install the transducers horizontally by the side of the pipe.

There are three ways to mount the transducers on the pipe: by magnetic force, by clamp-on fixture and by hand. If the pipe material is metal, the magnetic force will hold the transducer on the pipe. Otherwise, you may either simply hold the transducer handle and press it against the pipe (for S-type only) if you just need a quick measurement, or, you may use or a metal strip or the provided clamp fixture to install the transducers (see the figure 6.)

TRANSDUCER CLAMP DOWN

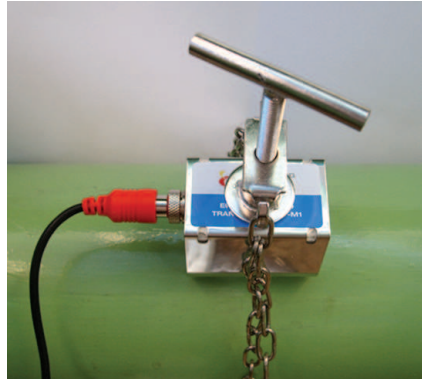

f. 6

NOTE



IT IS RECOMMENDED TO USE THE CONDUCTIVE GEL PRODUCT FROM LIVINGSTONE, AS THE ULTRASONIC COUPLANT FOR SAFETY CONSIDERATIONS. OTHER COUPLANT, SUCH AS GREASE, GEL, AND VASELINE, CAN BE USED AS ALTERNATIVES, BUT AT YOUR OWN RISK.

2.8.1 TRANSDUCER SPACING

The spacing value shown on menu window M25 refers to the distance of inner spacing between the two transducers (see the following figure). The actual distance of the two transducers should be as close as possible to this spacing value.

2.8.2 V METHOD INSTALLATION

V-method installation is the most widely used method for daily measurement with pipe inner diameters ranging from 20 millimetres to 300 millimetres. It is also called reflective method.

TRANSDUCER V METHOD MOUNTING

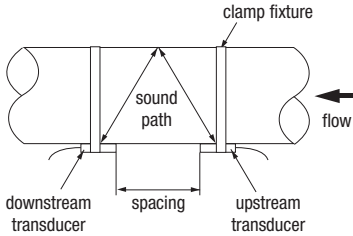

f. 7

TRANSDUCER W METHOD MOUNTING

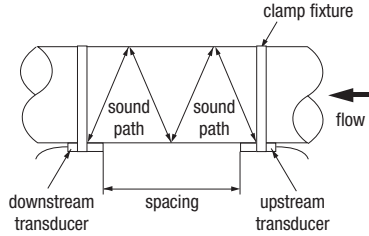

f. 9

2.8.3 Z METHOD INSTALLATION

Z-method is commonly used when the pipe diameter is between 100 millimetres' and 500 millimetres. This method is the most direct for signal transfer and can therefore provide better results than V method on many applications.

TRANSDUCER Z METHOD MOUNTING

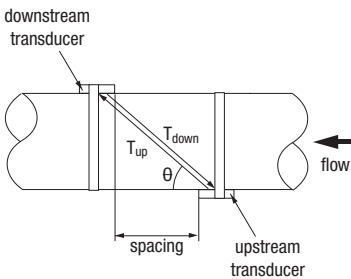

f. 8

2.8.4 W METHOD INSTALLATION

W-method is usually used on plastic pipes with a diameter from 10 millimetres to 100 millimetres. This method can be effective on smaller pipes that have internal deposits.

2.9 INSTALLATION TESTING

After completion of the transducer installation, the user should check the following items: the receiving signal strength, the signal quality Q value, the delta time (travelling time difference between the upstream and the downstream signals), the estimated liquid sound speed, the transit time ratio, and etc. As such, one can be sure that the flow meter is working properly and the results are reliable and accurate.

2.9.1 SIGNAL STRENGTH

Signal strength indicates the amplitude of receiving ultrasonic signals by a 3-digit number. [000] means there is no signal detected and [999] refers to the maximum signal strength that can be received.

Although the instrument works well when the signal strength ranges from 500 to 999, stronger signal strength should be pursued, because a stronger signal means a better result. The following methods are recommended to obtain strong signals:

- 1) If the current location is not good enough for a stable and reliable flow reading, or if the signal

strength is lower than 700, relocate to a more favourable location.

2) Try to polish the outer surface of the pipe, and apply more couplant to increase the signal strength.

3) Tenderly adjust the position of the two transducers, both vertically and horizontally, while checking the signal strength. Stop at the position where the signal strength reaches to maximum. Then, check the transducer spacing to make sure it is the same as or very close to what window M25 shows.

2.9.2 SIGNAL QUALITY

Signal quality is indicated as the Q value in the instrument. A higher Q value would mean a higher Signal to Noise Ratio (short for SNR), and accordingly a higher degree of accuracy able to be achieved. Under normal pipe condition, the Q value is in the range of 60-90, the higher the better.

Causes for a lower Q value could be:

1. Interference from other instruments and devices nearby, such as a power frequency inverter which could cause strong interference. Try to relocate the flow meter to a new place where the interference can be reduced.

2. Bad sonic coupling between the transducers and the pipe. Try to polish the pipe surface again, clean the surface and apply more couplant, etc.

3. The selected pipe section is difficult to conduct the measurement. Relocate to a more favourable pipe line.

2.9.3 TOTAL TRANSIT TIME AND DELTA TIME

The total transit time (or travelling time) and the delta time are displayed on menu window M93. They are the primary data for the instrument to calculate the flow rate. Therefore, the measured flow rate will vary as the total transit time and delta time vary.

The total transit time should remain stable or vary in a very small range.

The delta time normally varies less than 20%. If the variation exceeds 20% in either positive or negative direction, there could be certain kinds of problems with the transducer installation. The user should check the installation for sure.

2.9.4 TRANSIT TIME RATIO

This ratio is usually used to check whether the transducer installation is good and whether the entered pipe parameters are in consistency with their actual values. If the pipe parameters are correct and the transducers are installed properly, the transit time ratio should be in the range of 100 ± 3 . If this range is exceeded, the user should check:

1. Are the entered pipe parameters are correct?

2. Is the actual spacing of the transducers the same as or very closed to what shown on window M25?

3. Are the transducers installed properly and in the right direction?

4. Is the mounting location suitable and/or has the pipe changed shape? Is the pipe too old (i.e., too much corrosion or deposition inside)?

5. Is there any interference source inside the pipe?

6. Are there any other details that do not meet the measurement requirements as recommended before?

3. HOW TO CHECK AND SETUP

3.1 HOW TO CHECK IF THE INSTRUMENT WORKS PROPERLY

Generally speaking, when 'R' is displayed in the lower right corner of the LCD display, the instrument is working properly.

If an 'H' flashes instead, the received signal could be poor. Please refer to the chapter on diagnosis for more information.

If an 'I' is displayed, it means that there is no signal detected.

If a 'J' is displayed, it means that the hardware of this instrument could be out of order. Refer to the *chapter on diagnosis*.

3.2 HOW TO CHECK THE LIQUID FLOW DIRECTION

Check the flow rate display. If the value is POSITIVE, the direction of the flow will be from the RED transducer to the BLUE transducer; if the value is NEGATIVE, the direction will be from the BLUE transducer to the RED transducer.

3.3 HOW TO CHANGE THE UNIT READINGS

Use menu window M30 for the selection of units systems, either English or in Metric.

3.4 HOW TO SELECT A FLOW RATE

Use menu window M31 to select the flow rate unit as well as the corresponding time unit.

3.5 HOW TO USE THE TOTALIZER MULTIPLIER

Use window M33 to select a proper multiplying factor for the totalizer multiplier. Make sure that the rate of the totalizer pulse is not too fast, neither too slow. A speed of several pulses per minute is preferable.

If the totalizer multiplying factor is too small, the output pulse will be very fast and there could be a loss of pulses. The designed minimum pulse period is 500 milliseconds.

If the totalizer multiplying factor is too large, the output pulse will be very slow, which might be a problem if the master device requires fast response.

3.6 HOW TO SET THE TOTALIZER FUNCTIONS

The flow meter has three totalize functions, generally you will only need the Pos totalizer set as most pipes will have flow in one direction only.

Use M34, M35 and M36 to turn on or turn off the POS, NEG, or NET totalizer, respectively.

3.7 HOW TO RESET TOTALIZERS

Use M37 to reset the flow rate totalizers.

3.8 HOW TO RESTORE THE FACTORY DEFAULTS

Go to window M37. Press  key followed by the backspace key .

This operation will erase all the parameters entered by the user and setup the instrument with factory default values.

3.9 HOW TO USE THE DAMPER TO STABILISE THE FLOW RATE

The damper acts as a filter for a stable reading. If '0' is entered in window M40, that means there is no damping. A bigger number brings a more stable effect. But bigger damper numbers will prevent the instrument from acting quickly.

Numbers of 0 to 10 are commonly used for the damper value.

3.10 HOW USE THE ZERO CUT OFF FUNCTION



The number displayed in window M41 is called the zero-cut-off value. When the absolute value of the measured flow rate is less than the zero-cut-off value, the measured flow rate will be replaced with '0'. This is to avoid any invalid accumulation when the actual flow is below the zero-cut-off value.

The zero-cut-off operation does not affect the flow measurement when the actual flow is greater than the zero-cut-off value.

3.11 HOW TO SET A ZERO POINT

When the flow in a pipe is absolutely stopped, the flow meter could still give a small non-zero flow rate reading. In order to make the measurement accurate, it is necessary to remove this "zero point" reading. Window M42 allows us to take care of this issue. At first, the user should make sure that the liquid in the pipe is totally stopped (no velocity). Then, go to window M42 and press the  key to start the zero point setup function.

3.12 HOW TO CHANGE THE FLOW RATE SCALE FACTOR

A scale factor (SF) is the ratio between the 'actual flow rate' and the flow rate measured by the flow meter. It can be determined by calibration with a standard flow calibration equipment. To change the SF, press M45, then the  key, enter the new SF, and press  again.

3.13 HOW TO SET AND LOCK THE PASSWORD

The password lock provides a means of preventing inadvertent configuration changes or totalizer resets.

When the system is locked, the user can still browse menu windows, but cannot make any modifications on the windows.

The password locking / unlocking is done in window M47. The system can be locked without a password or with a password consisted of 1 to 4 digits.

For no-password locking / unlocking, just press  key in window M47.



3.14 HOW TO USE THE INBUILT DATA LOGGER

The built-in data logger has a space of 24K bytes of memory, which will hold about 2000 lines of data.

Use M50 to turn on the logger and to select the items that are going to be logged.

Use M51 to set up the starting time, time interval, and the duration each logging lasts.

Use M52 to select the data storage direction. Data can be stored in a logger buffer or directed to the RS-232C interface without being stored into the logger buffer.

Use M53 to view the data in the logger buffer.

User needs to go to window M52 to clear the logging data remained in the RS-232C interface and in the logger buffer.

3.15 HOW TO USE THE FREQUENCY OUTPUT

The flow meter will produce a pulse output with every unit of liquid flow. This pulse could be used by an external pulse counter to accumulate the flow rate.

Refer to 3.4 and 3.5 for the setup of the totalizer units and multiplier.

The totalizer pulse output can only be connected to OCT devices or BUZZER hardware devices.

For example, assume that the POS totalizer pulse output is needed, and every pulse represents 0.1 cubic meter of liquid flow. Assume also that the pulse output is connected to an internal Buzzer. With every 0.1 cubic meter of flow, we need the BUZZER to beep for a while. In order to achieve this, the following steps must be performed:

- Select the Cubic Meter (m3) unit in window M32.
- Select the Multiplier factor as '2. X0.1' in window M33.
- Select the output option '9. POS INT Pulse' in window M77. (INT stands for totalized)

3.16 HOW TO USE THE TOTALIZER PULSE OUTPUT

The flow meter will produce a pulse output with every unit of liquid flow. This pulse could be used by an external pulse counter to accumulate the flow rate.

Refer to 3.4 and 3.5 for the setup of the totalizer units and multiplier.

The totalizer pulse output can only be connected to OCT devices or BUZZER hardware devices.

For example, assume that the POS totalizer pulse output is needed, and every pulse represents 0.1 cubic meter of liquid flow. Assume also that the

pulse output is connected to an internal Buzzer. With every 0.1 cubic meter of flow, we need the BUZZER to beep for a while. In order to achieve this, the following steps must be performed:

- 1) Select the Cubic Meter (m3) unit in window M32.
- 2) Select the Multiplier factor as '2. X0.1' in window M33.
- 3) Select the output option '9. POS INT Pulse' in window M77. (INT stands for totalized)

3.17 HOW TO PRODUCE AN ALARM SIGNAL

There are 2 types of hardware alarm signals that are available with this instrument. One is the Buzzer, and the other is the OCT output.

The triggering sources of the alarming events for both the Buzzer and the OCT output could be:

- 1) There is no receiving signal
- 2) The signal received is too weak.
- 3) The flow meter is not in normal measurement modes.
- 4) The flow direction is changed.
- 5) Overflow occurs at the Frequency Output
- 6) The flow is out of the specified range.

There are two alarms in this instrument, #1 alarm and #2 alarm. They can be configured in windows M73, M74, M75 and M76.

For example, assume we need the Buzzer to start beeping when the flow rate is less than 300 m3/h and greater than 2000m3/h. The following setup steps would be recommended.

- 1) Enter flow rate lower limit 300 in M73 for #1 alarm,
- 2) Enter flow rate upper limit 2000 in M74 for #1 alarm,
- 3) Select item '6. Alarm #1' in M77.

3.18 HOW TO USE THE BUILT IN BUZZER

The built-in buzzer is user-configurable. It can be used as an alarm. Use M77 for setups.

3.19 HOW TO USE THE OCT PULSE OUTPUT

The OCT output is on/off type. It is user-configurable. For example, you can set the OCT output to be a pulse signal for flow accumulation.



Use M77 for the setup.

Notice that the Frequency Output shares the same OCT hardware.

The OCT output is wired to pin 6 (for positive) and pin 5 (for ground) of the RS-232 connector. Refer to *section 6.1* for more details.

3.20 HOW TO SET THE BUILT IN CALENDAR

No modification on the built-in calendar will be needed in most cases. The calendar consumes insignificant amount of power. Modification will be needed only when the battery is totally exhausted, or when the replacement of the batteries takes a long time so that the original clock data get lost.

Press the  key in M61 for Modification. Use  key to skip over these digits that need no modification.

3.21 HOW TO ADJUST THE LCD CONTRAST

Use M70 to adjust the LCD contrast. The adjusted results will be stored in the EEPROM so that the MASTER ERASE (factory default restoration) will make no effect on the contrast.

3.22 HOW TO USE THE RS232 SERIAL INTERFACE

Use M62 for the setup of the RS-232C serial interface.

3.23 HOW TO VIEW THE TOTALIZERS

Use M82 to view the daily totalizer, the monthly totalizer and the yearly totalizer.

3.24 HOW TO USE THE WORKING TIMER

Use the working timer to check the time that has passed with a certain kind of operation. For example, use it as a timer to show how long a fully-charged battery will last.

In window M72, press **ENT** key and select YES to reset the working timer.

3.25 HOW TO USE THE MANUAL TOTALIZER

Use M82 to view the daily totalizer, the monthly totalizer and the yearly totalizer.

3.26 HOW TO CHECK THE SERIAL NUMBER

Every set of the flow meters utilizes a unique ESN to identify the meter. The ESN is an 8-digit number that provides the information of version and manufacturing date.

The user can also employ the ESN for instrumentation management.

The ESN is displayed in window M61.

Use M+1 to view the total working time since the

instrument was shipped out of the manufacturer.

Use M+4 to view the total number of times the instrument has been turned on and off since the instrument was shipped out of the manufacturer.

3.27 HOW TO CHECK THE BATTERY LIFE

Use M07 to check how long the battery will last. Also please refer to 2.1 for further details.







3.28 HOW TO CHARGE THE BATTERY

Refer to *section 2.1*

4. MENU WINDOW DETAILS

Menu window No.	Function
M00	Display POS (positive), NEG (negative) and NET (net) totalizer values. Display signal strength, signal quality and working status.
M01	Display POS totalizer, instantaneous flow rate, velocity, signal strength, signal quality and working status.
M02	Display NEG totalizer, instantaneous flow rate, velocity, signal strength, signal quality and working status.
M03	Display NET totalizer, instantaneous flow rate, velocity, signal strength, signal quality and working status.
M04	Display date and time, instantaneous flow rate, signal strength, signal quality and working status.
M05	Display date and time, velocity, signal strength, signal quality and working status.
M06	Display the wave shape of the receiving signal.
M07	Display the battery terminal voltage and its estimated lasting time.
M08	Display all of the detailed working status, signal strength, signal quality.
M09	Display today's total NET flow, velocity, signal strength, signal quality and working status.
M10	Window for entering the outer perimeter of the pipe.
M11	Window for entering the outer diameter of the pipe Valid range: 0 to 6000mm.
M12	Window for entering pipe wall thickness. Valid range: 0-55mm
M13	Window for entering the inner diameter of the pipe. If pipe outer diameter and wall thickness are entered correctly, the inner diameter will be calculated automatically, thus no need to change anything in this window. Valid range: 0-6000mm
M14	Window for selecting pipe material. Standard pipe materials (no need to enter the material sound speed) include: 0) carbon steel 1) stainless steel 2) cast iron 3) ductile iron 4) copper 5) PVC 6) aluminium 7) asbestos 8) fiberglass 9) Other
M15	Window for entering the sound speed of non-standard pipe materials
M16	Window for selecting the liner material. Select none for pipes without any liner. Standard liner materials (no need to enter liner sound speed) include: 1) Tar Epoxy 2) Rubber 3) Mortar 4) Polypropylene 5) Polystyrol 6)Polystyrene 7) Polyester 8) Polyethylene 9) Ebonite 10) Teflon
M17	Window for entering the sound speed of non-standard liner materials
M18	Window for entering the liner thickness, if there is a liner
M19	Window for entering the roughness coefficient of the pipe inner surface

Menu window No.	Function
M20	Window for selecting fluid type For standard liquids (no need to enter liquid sound speed) include: 0) Water 1) Sea Water 2) Kerosene 3) Gasoline 4) Fuel oil 5) Crude Oil 6) Propane at -45C 7) Butane at 0C 8)Other liquids 9) Diesel Oil 10)Caster Oil 11)Peanut Oil 12) #90 Gasoline 13) #93 Gasoline 14) Alcohol 15) Hot water at 125C
M21	Window for entering the sound speed of non-standard liquids
M22	Window for entering the viscosity of non-standard liquids
M23	Window for selecting transducer type There are 14 different types of transducers for selection. If the π type spool-piece transducers are used, the user needs to configure the 3 transducer parameters. Otherwise, the user needs to configure the 4 transducer parameters.
M24	Window for selecting the transducer mounting methods Four methods can be selected: 0) V-method 1) Z-method 2) N-method 3) W-method
M25	Display the transducer mounting spacing or distance
M26	Entry to store the pipe parameters into the internal NVRAM (non-volatile memory)
M27	Entry to read the previously saved pipe parameters
M28	Entry to determine whether or not to keep the last correct value when poor signal condition occurs. YES is the factory default
M29	Window to set the threshold below which the receiving signal is defined as poor. Valid number: from 000 to 999. 0 is the factory default
M30	Window for selecting unit system. 'Metric' is the factory default. The conversion from English to Metric or vice versa will not affect the unit for totalizers.
M31	Window for selecting flow rate unit system. Flow rate can be in 0. Cubic meter short for (m ³) 1. Liter (l) 2. USA gallon (gal) 3. Imperial Gallon (igl) 4. Million USA gallon (mgl) 5. Cubic feet (cf) 6. USA liquid barrel (bal) 7. Imperial liquid barrel (ib) 8. Oil barrel (ob) The flow unit in terms of time can be per day, per hour, per minute or per second. So there are 36 different flow rate units in total for selection.
M32	Window for selecting the totalizers' unit
M33	Window for setting the totalizer multiplying factor The multiplying factor ranges from 0.001 to 10000

Menu window No.	Function
M34	Turn on or turn off the NET totalizer
M35	Turn on or turn off the POS totalizer
M36	Turn on or turn off the NEG totalizer
M37	(1) Totalizer reset (2) Restore the factory default settings. Press the  key followed by the  key. Attention, it is recommended to make notes on the parameters before doing the restoration.
M38	Manual totalizer used for calibration. Press any key to start and press the key again to stop the totalizer.
M39	Language selection, Chinese or English.
M40	Flow rate damper setup. The damping parameter ranges from 0 to 999 seconds. 0 means there is no damping. Factory default is 10 seconds.
M41	Zero flow rate (or low flow rate) cut-off to avoid invalid accumulation.
M42	Zero point setup. Make sure the liquid in the pipe is not running while doing this setup.
M43	Clear the zero point value, and restore the factory default zero point.
M44	Set up a flow bias. Generally this value should be 0.
M45	Flow rate scale factor. The factory default is '1'. Keep this value as '1' when no calibration has been made.
M46	Network address identification number (IDN). Any integer can be entered except 13(ODH, carriage return), 10 (OAH, line feeding), 42 (2AH), 38, 65535. Every set of the instrument in a network environment should have a unique IDN. Please refer to the <i>chapter for communications</i> .
M47	System lock to avoid modification of the system parameters
M48	Not used
M49	Window for network communication test
M50	Window to set up the schedule-based data saving. Select the items to be saved.
M51	Window to set up the schedule for the schedule-based data saving
M52	Data output direction control. If 'To RS-232' is selected, all the data will be directed to the RS-232 interface If 'To buffer' is selected, the data will be stored into the built-in logger memory Allow user to clear data buffer
M53	Logger buffer viewer. It functions as a file editor. Use  ,  ,  and  keys to browse the buffer. If the logger is ON, the viewer will automatically refresh once new data are stored
M54	Not used
M55	Nod used
M56	Not used
M57	Not used

Menu window No.	Function
M58	Not used
M59	Not used
M60	99 years calendar. Press ENT for modification. Use the ◁ key to skip the digits that need no modification.
M61	Display Version information and Electronic Serial Number (ESN) that are unique for each flow meter. The user can use the ESN for instrumentation management
M62	RS-232 setup. Baud rate can be 75 to 115,200 bps
M63	Not used
M64	Not used
M65	Not used
M66	Not used
M67	Window to set up the frequency range (lower limit and upper limit) for the frequency output. Valid values: 0Hz-9999Hz. Factory default is 1-1001 Hz
M68	Window to set up the minimum flow rate which corresponds to the lower frequency limit of the frequency output
M69	Window to set up the maximum flow rate which corresponds to the upper frequency limit of the frequency output
M70	LCD display backlight control. The entered value indicates how many seconds the backlight will be on with every key pressing.
M71	LCD contrast control. The LCD will become darker when a small value is entered.
M72	Working timer. It can be reset by pressing ENT key, and then select YES.
M73	Alarm #1 lower threshold setup. Below this threshold the #1 Alarm will be triggered. There are two alarming methods. User must select the alarming output items from window M78 or M77
M74	Alarm #1 upper threshold setup
M75	Alarm #2 lower threshold setup
M76	Alarm #2 upper threshold setup
M77	Buzzer setup. If a proper input source is selected, the buzzer will beep when the trigger event occurs
M78	OCT (Open Collector Output) setup By selecting a proper triggering source, the OCT circuit will close when the trigger event occurs
M79	Not used
M80	Not Used
M81	Not used
M82	Setup for daily totalizer, monthly totalizer and yearly totalizer
M83	Not used
M84	Not used

Menu window No.	Function
M85	Not used
M86	Not used
M87	Select transducer power between 1-10 (default 10)
M88	Set receive window start
M89	Set receive window end
M90	Display signal strength, signal quality and transit time ratio (upper right corner).
M91	Display the transit time ratio. The ratio value should be in the range of $100\pm 3\%$ if the entered pipe parameters are correct and the transducers are properly installed. Otherwise, the pipe parameters and the transducer installation should be checked.
M92	Display the estimated sound speed of the fluid in the pipe. If this value has an obvious difference with the actual fluid sound speed, the user is recommended to check if the pipe parameters are correct and if the transducer installation is good.
M93	Display the total transit time and delta time (transit time difference between upstream and downstream travelling)
M94	Display the Reynolds number and the pipe factor used by the flow rate measurement program. Note, the pipe factor is rarely used.
M95	Not used
M96	Not used
M97	Command to store the pipe parameters either in the built-in data logger or to the RS-232C serial interface
M98	Command to store the diagnostic information either in the built-in data logger or to the RS-232C serial interface
M99	Command to copy the current display either to the built-in data logger or to the RS-232C serial interface
M+0	View the last 64 records of power on and off events. The recorded information include the date and time as well as the corresponding flow rate when the power on or off occurs
M+1	Display the total working time of the instrument
M+2	Display the last power-off date and time
M+3	Display the last power-off flow rate
M+4	Display the total number of times the flow meter has been powered on and off
M+5	A scientific calculator for the convenience of field applications. All the values are in single accuracy. All the mathematic operators are selected from a list.
M+6	Velocity change setup
M+7	Protocol selection
M+8	Not used
M+9	Not used
M-0	Entry to hardware adjusting windows. Valid for the manufacturer only.

5. TROUBLESHOOTING

5.1 POWER-ON ERRORS

When powered on, the ultrasonic flow meter automatically starts the self-diagnosis process to find if there are any hardware and software problems. If a problem is identified, an error message will be displayed. The following table shows the possible error messages, the corresponding causes and their solutions.

Error message	Causes	Solutions
ROM Testing Error	Problem with the software	1)Reboot the system
Data Testing Error		2)Contact the manufacturer.
Data Storing Error	User-entered parameters get lost.	When this message is displayed, press ENT key to restore the default configuration.
System Clock Slow or Fast Error	Problem with the system clock or the crystal oscillator.	1)Power on again 2)Contact the manufacturer
Date Time Error	Problem with the system calendar	Initialize the calendar in menu window M61
Reboot repetitively	Hardware problems	Contact the manufacturer

5.2 WORKING STATUS ERRORS

The ultrasonic flow meter will show an Error Code (a single letter like I, R, etc.) in the lower right corner on menu windows M00, M01, M02, M03, M90 and M08. When any abnormal Error Code shows, counter-measures should be taken.

Error code	Message on window M08	Causes	Solutions
R	System Normal	No error	
I	No Signal	1)Unable to receive signals 2)Transducers installed improperly 3)Loosen contact or not enough couplant between transducer and pipe outer surface. 4)Pipe liners are too thick or the deposition inside of the pipe is too thick. 5)Transducer cables are not properly connected	1) Adjust measuring location 2)Polish the pipe surface and clean the spot 3)Make sure the couplant is enough 4)Check the transducer cables

It continues in the following page

It comes from the previous page

Error code	Message on window M08	Causes	Solutions
J	Hardware Error	Hardware problem	Contact the manufacturer
H	Poor Sig. Detected	1)Poor signal detected 2)Transducers installed improperly 3)Too much fouling (corrosion, deposition, etc.) 4)The pipe liner is too thick. 5)Problem with transducer cables	1)Adjust measuring location 2)Polish the pipe surface and clean the spot 3)Make sure the couplant is enough 4)Check the transducer cables
Q	Frequency Output Over	The actual frequency for the Frequency Output is out of the range specified by the user	Check the values entered in window M66, M67, M68 and M69, and use a larger value in M69
F	System RAM Error Date Time Error CPU or IRQ Error ROM Parity Error	1) Temporary problems with RAM, RTC 2) Permanent problems with hardware	1) Turn on the power again 2) contact the manufacturer
1 2 3	Adjusting Gain	Instrument is in the progress of adjusting the gain for the signal, and the number indicates the progressive steps	No need for action
K	Empty pipe	No liquid inside the pipe Incorrect setup in M29	Relocate the meter to where the pipe is full of liquid Enter 0 in M29

5.3 OTHER PROBLEMS AND SOLUTIONS

1) Q: Why the instrument displays 0.0000 flow rate while the liquid in the pipe is actually flowing? The signal strength is checked to be good (the working status is "R") and the signal quality Q has a satisfactory value.

A: The problem is likely to be caused by the incorrect "Zero Point" setting. The user may have conducted the "Zero Point" setup while the flow was not standstill. To solve this problem, use the 'Reset Zero' function in menu window M43 to clear the zero point.

2) Q: The displayed flow rate is much lower or much higher than the actual flow rate in the pipe under normal working conditions. Why?

*A: The entered offset value might be wrong. Enter '0' offset in window M44.
Incorrect transducer installation. Re-install the transducers carefully.
The 'Zero Point' is wrong. Go to window M42 and redo the "Zero Point" setup. Make sure that the flow inside the pipe is standstill. No velocity is allowed during this setup process.*

3) Q: Why the battery can not work as long as the time indicated on M07?

*A: The battery may have come to the end of its service life. Replace it with a new one.
New battery is not compatible with the battery estimating software. The software needs to be upgraded. Please contact the manufacturer.
The battery has not been fully charged.
There is indeed a time difference between the actual working time and the estimated one, especially when the terminal voltage is in the range from 3.70 to 3.90 volts. Therefore, the estimated working time is for reference only*

6. COMMUNICATION PROTOCOL

The ultrasonic flow meter integrates a standard RS-232C communication interface and a complete set of communication protocol.

6.1 RS232 CONNECTOR PIN-OUT

RS232 WIRING DIAGRAM

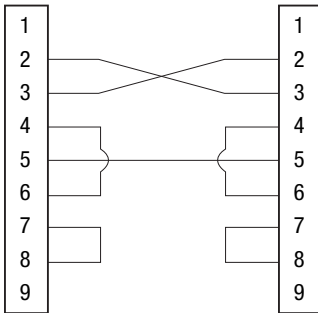

REFERENCES

Pin	Definition
1	Not Used
2	RXD
3	TXD
4	DTS
5	GND
6	DSR
7	+5V
8	Not Used
9	Ring input for connecting a modem

f. 10

6.2 COMMUNICATION PROTOCOL

The protocol is comprised of a set of basic commands that are strings in ASCII format, ending with a carriage (CR) and line feed (LF). Commonly used commands are listed in the following table.

6.2.1 BASIC COMMANDS

Command	Function	Data Format
DQD(CR) ¹	Return flow rate per day	±d.dddddE±dd(CR) (LF) ²
DQH(CR)	Return flow rate per hour	±d.dddddE±dd(CR) (LF)
DQM(CR)	Return flow rate per minute	±d.dddddE±dd(CR) (LF)
DQS(CR)	Return flow rate per second	±d.dddddE±dd(CR) (LF)
DV(CR)	Return instantaneous flow velocity	±d.dddddE±dd(CR) (LF)
DI+(CR)	Return POS totalizer	±ddddddE±d(CR) (LF) ³
DI-(CR)	Return NEG totalizer	±ddddddE±d(CR) (LF)

It continues in the following page

It comes from the previous page

Command	Function	Data Format
DIN(CR)	Return NET totalizer	±d.dddddddE±d(CR) (LF)
DIE(CR)	Return Caloric Totalizer Value	±d.dddddddE±d(CR) (LF)
DID(CR)	Return Identification Number (IDN)	ddddd(CR) (LF)
E(CR)	Return Instantaneous Caloric Value	±d.dddddddE±dd(CR) (LF)
DL(CR)	Return signal strength and signal quality	UP:dd.d, DN:dd.d, Q=dd(CR)(LF)
DS(CR)	Return the percentage of analogue output A0.	±d.dddddddE±dd(CR) (LF)
DC(CR)	Return the present error code	4
DA(CR)	OCT or RELAY alarm signal	TR:s, RL:s(CR)(LF) ⁵
DT(CR)	Return the current date and time	yy-mm-dd hh:mm:ss(CR)(LF)
M@(CR)****	Send a key value as if a key is pressed	M@(CR))(LF) ⁶
LCD(CR)	Return the current display contents	
C1(CR)	OCT close	
C0(CR)	OCT open	
R1(CR)	RELAY close	
R0(CR)	RELAY open	
F0ddd(CR)	Force the FO output to output a frequency of dddd Hz	Fddd(CR)(LF)
A0a(CR)	Output current a at the current loop output terminal	A0a(CR)(LF) ⁷
BA1(CR)	Return current value of AI1 (0-20mA)	±d.dddddddE±dd(CR) (LF)
BA2(CR)	Return current value of AI2 (0-20mA)	±d.dddddddE±dd(CR) (LF)
BA3(CR)	Return current value of AI3 (0-20mA)	±d.dddddddE±dd(CR) (LF)
BA4(CR)	Return current value of AI4 (0-20mA)	±d.dddddddE±dd(CR) (LF)
AI1(CR)	Return temperature/pressure value of AI1	±d.dddddddE±dd(CR) (LF)
AI2(CR)	Return temperature/pressure value of AI2	±d.dddddddE±dd(CR) (LF)
AI3(CR)	Return temperature/pressure value of AI3	±d.dddddddE±dd(CR) (LF)
AI4(CR)	Return temperature/pressure value of AI4	±d.dddddddE±dd(CR) (LF)
ESN(CR)	Return the electronic serial number (ESN) of the flow meter	dddddddt(CR)(LF) ⁸
W	Prefix of an IDN-addressing-based networking command. The IDN address is a word, ranging 0-65534.	⁹
N	Prefix of an IDN-addressing-based networking command. The IDN address here is a single byte value, ranging 00-255.	⁹
P	Prefix of any command with checksum	
&	Command binder to make a longer command by combining up to 6 commands	
RING(CR)(LF)	Handshaking Request from a MODEM	ATA(CR) (LF)

It continues in the following page

It comes from the previous page

Command	Function	Data Format
OK(CR)	Acknowledgement from a MODEM	No action
	Handshaking Request from a Flow meter	AT(CR) (LF)
GA(CR)	A Command for GSM messaging ¹⁰	Please contact the manufacturer for detail
GB(CR)	B Command for GSM messaging ¹⁰	
GC(CR)	C Command for GSM messaging	
DUMP ¹¹	Return the print buffer content	In ASCII string format
DUMPO	Clear the whole print buffer	In ASCII string format
DUMP1(CR)	Return the whole print buffer content	In ASCII string Format (24KB long)

Notes:

1. (CR) stands for Carriage Return. Its ASCII code is 0DH. (LF) strands for Line Feed. Its ASCII code is 0AH.

2. "d" stands for a digit number of 0~9. 0 is expressed as +0.000000E+00.

3. "d" stands for a digit number of 0~9. The number before "E" is integer.

4. Working status code, 1-6 letters. Refer to Table 5.2 for error code.

5. "s" is "ON", "OFF" or "UD". For instance, "TR:ON, RL:UD" means that the OCT is in closed state and RELAY is not used.

6. @ stands for key value. For instance, value 30H means key "0", command "M4" is equivalent to press key "4".

7. "a" stands for current value, a digit number of 0~20. For instance, A02.34, A00.2

8. "ddddddt" stands for 8-digit electronic serial number. "t" stands for flow meter type.

9. If there are more than one flow meters in a network, all the basic commands must be prefixed with N or W. Otherwise, multiple flow meters may reply to the same request.

10. Adding a GSM module to the flow meter allows the user to check flow meter flow rate and other parameters from a cell phone.

11. Used for visiting the printer buffer content.

6.2.2 PROTOCOL PREFIX USAGE

1) Prefix P

The prefix P can be added before any command in the above table to have the returning data followed with two bytes of CRC check sum, which is the adding sum of the original character string.

Take command DI+(CR) (Return POS Totalizer Value) as an example. The binary data for DI+(CR) is 44H, 49H, 2BH and 0DH. Assume the return value of this command is +1234567E+0m3(CR)(LF) (the string in hexadecimal is 2BH, 31H, 32H, 33H, 34H, 35H, 36H, 37H, 45H, 2BH, 30H, 6DH, 33H, 20H, 0DH, 0AH).

Then, the P-prefixed command, PDI+(CR), would

return +1234567E+0m3!F7(CR)(LF). The '!' acts as the starter of the check sum (F7) which is obtained by adding up the string, 2BH+ 31H+ 32H+ 33H+ 34H+ 35H+ 36H+ 37H+ 45H+ 2BH+ 30H+ 6DH+ 33H+ 20H = (2) F7H.

Please note that it is allowed to not have data entry or to have SPACES (20H) character before the '!' character.

2) Prefix W

The prefix W is used for networking commands. The format of a networking command is:

W + IDN address string + basic command.

The IDN address should have a value between 0 and 65534, except 13(ODH), 10 (OAH), 42(2AH,*), 38(26H, &).

For example, if you want to visit the instantaneous flow velocity of device IDN=12345, the following command should be sent to this device: W12345DV(CR). The corresponding binary code is 57H, 31H, 32H, 33H, 34H, 35H, 44H, 56H, 0DH.

3) Prefix N

The prefix N is a single byte IDN network address, not recommended in a new design.

4) Command binder &

The & command binder or connector can connect up to 6 basic commands to form a longer command so that it will make the programming much easier.

For example, assume we want device IDN=4321 to return the flow rate, velocity and POS totalizer value simultaneously. The combined command would be W4321DQD&DV&DI+(CR), and the result would be:

















+1.234567E+12m3/d(CR)
 +3.1235926E+00m/s(CR)
 +1234567E+0m3(CR)

6.3 THE M COMMAND AND THE ASCII CODES

The protocol provides the capability of virtual key-pressing. A remote RS-232C terminal can send an 'M' command along with a key code to simulate the scenario that the key is pressed through the keypad of the flow meter. This functionality allows the user to operate the flow meter in the office far away from the testing site.

For example, the command "M1" is sent to the flow meter through the RS-232C link, the flow meter will treat the command as if the user has pressed the  key through the keypad.

The ASCII codes and corresponding key values of the keypad keys are listed in the following table.

Key	Hexadecimal Key Code	Decimal Key Code	ASCII Code
	30H	48	0
	31H	49	1
	32H	50	2
	33H	51	3
	34H	52	4
	35H	53	5
	36H	54	6
	37H	55	7
	38H	56	8
	39H	57	9
	3AH	58	:
	3BH, 0BH	59	;
	3CH, 0CH	60	<
	3DH, 0DH	61	=
	3EH	62	>
	3FH	63	?

7. WARRANTY AND SERVICE

7.1 WARRANTY

The products manufactured by EUROMAG INTERNATIONAL are warranted to be free from defects in materials and workmanship for a period of one year from the date of shipment to the original purchaser. EUROMAG INTERNATIONAL's obligation should be limited to restoring the meter to normal operation or replacing the meter, at EUROMAG's choice, and shall be conditioned upon receiving written notice of any alleged defect within 10 days after its discovery. EUROMAG INTERNATIONAL will determine if the return of the meter is necessary. If it is, the user should be responsible for the one-way shipping fee from the customer to the manufacturer.

EUROMAG INTERNATIONAL is not liable to any defects or damage attributable to miss usage, improper installation, out-of-spec operating conditions, replacement of unauthorized parts and acts of nature. Besides, fuses and batteries are not part of this warranty.

THE FOREGOING WARRANTY IS EXCLUSIVE AND IN LIEU OF ALL OTHER EXPRESS OR IMPLIED WARRANTIES (INCLUDING BUT NOT LIMITED TO WARRANTIES OF MERCHANTABILITY AND FITNESS FOR A PARTICULAR PURPOSE, AND WARRANTIES ARISING FROM DEALING, TRADE OR USAGE.)

7.2 SERVICE

For operational problems, please contact the technical support department by telephone, fax, email or internet. In most cases, problems could be solved immediately.

For any hardware failure of the instrument, we recommend our customers to send back the instrument for service. Please contact the technical support department with the model number and serial number of the unit before sending the unit back to us. Both numbers can be found on the product label. For each service or calibration request, we will issue a Return Materials Authorisation (RMA) number.

Take notice that the cost for repairing can only be determined after receipt and inspection of the instrument. A quotation will be sent to the customer before proceeding with the service.

Important Notice for Product Return

Before returning the instrument for warranty repair or service, please read the following carefully:

1. If the return item has been exposed to nuclear or other radioactive environment, or has been in contact with hazardous material which could pose any danger to our personnel, the unit cannot be serviced.
2. If the return item has been exposed to or in contact with dangerous materials, but has been certified as hazard-free device by a recognized organization, you are required to supply the certification for the service.
3. If the return item does not have a RMA# associated, it will be sent back without any service conducted.

8. APPENDIX

8.1 BATTERY MAINTENANCE AND REPLACEMENT

The battery is Ni-MH rechargeable battery. Therefore, it is recommended to discharge the battery by leaving the instrument ON (it will automatically turn OFF after a few minutes) every 3 months. Recharge the battery again to its full extend with the supplied AC adapter. Generally, when the green LED is on, the battery is nearly 95% charged, and when the red LED is off, the battery is nearly 98% charged.

When the battery is unable to power the instrument for 2 to 3 hours after it is fully recharged, this usually indicates that the battery is near its product life and needs to be replaced. Please consult the manufacturer for replacing the battery pack.

8.2 PIPE SIZE TABLES

8.2.1 STANDARD PIPE SIZE CHARTS FOR COPPER

Classification: Copper tube is classified into four different specification types based on wall thickness for a specific outside diameter. The tables provided below are for reference sizing based on application:

EN 1057 - TYPE Y (PREVIOUSLY BS 2871 TABLE Y)

Size	Nom. Dia. (Outside)	Nom. Wall Thickness	Max. Working Pressures*		
			Half Hard	Hard	Annealed
mm	mm	mm	bar+	bar+	bar+
6	6	0.8	188	223	144
8	8	0.8	136	161	105
10	10	0.8	106	126	82
12	12	0.8	87	104	67
15	15	1.0	87	104	67
18	18	1.0	72	85	55
22	22	1.2	69	84	53
28	28	1.2	55	65	42
35	35	1.5	54	65	41
42	42	1.5	45	54	34
54	54	2.0	47	56	36
66.7	66.7	2.0	37	45	28
76.1	76.1	2.0	33	39	25
108	108	2.5	29	34	22

*Based on designated temper at 65°C

+1 bar = 0.1N/mm² = 10⁵ N/m²

Usage: Underground works and heavy duty requirements including hot and cold water supply, gas reticulation, sanitary plumbing, heating and general engineering.

ADDED
TOUGHNESS & DURABILITY

EN 1057 - TYPE X (PREVIOUSLY BS 2871 TABLE X)

Size	Nom. Dia. (Outside)	Nom. Wall Thickness	Max. Working Pressures*		
			Half Hard	Hard	Annealed
mm	mm	mm	bar ⁺	bar ⁺	bar ⁺
6	6	0.6	133	161	102
8	8	0.6	97	118	75
10	10	0.6	77	93	59
12	12	0.6	63	76	48
15	15	0.7	58	71	45
18	18	0.8	56	67	43
22	22	0.9	51	62	39
28	28	0.9	40	48	31
35	35	1.2	42	51	33
42	42	1.2	35	43	27
54	54	1.2	27	33	21
66.7	66.7	1.2	20	27	17
76.1	76.1	1.5	24	29	18
108	108	1.5	17	20	13
133	133	1.5	14	17	10
159	159	2.0	15	18	12

*Based on designated temper at 65°C ⁺1 bar = 0.1N/mm² = 10⁵ N/m²

Usage: Above ground services including drinking water supply, hot and cold water systems, sanitation, central heating and other general purpose applications.

**ECONOMICAL AND
STRONG**

EN 1057 - TYPE Z (PREVIOUSLY BS 2871 TABLE X)

Size	Nom. Dia. (Outside)	Nom. Wall Thickness	Max. Working Pressures*
mm	mm	mm	bar⁺
6	6	0.5	113
8	8	0.5	98
10	10	0.5	78
12	12	0.5	64
15	15	0.5	50
18	18	0.6	50
22	22	0.6	41
28	28	0.6	32
35	35	0.7	30
42	42	0.8	28
54	54	0.9	25
66.7	66.7	1.0	20
76.1	76.3	1.2	19
108	108	1.2	17
133	133	1.5	16
159	159.5	1.5	15

*Based on designated temper at 65°C

⁺1 bar = 0.1N/mm² = 10⁵ N/m²

Usage: Above ground services including drinking water supply, hot and cold water systems, sanitation, central heating and other general purpose applications.

**LOW COST
UTILITY RANGE**

8.2.2 STANDARD PIPE SIZE CHARTS FOR PVC

Pipe mm	O/D		PN 6		PN 9		PN 12		PN 12		PN 12		Convert to inches			
	Min	Max	mm	I/D	Min	Max	mm	I/D	Min	Max	mm	I/D		Min	Max	mm
15	21.20	21.50	-	-	-	-	-	-	-	-	-	-	1.40	1.70	18.25	-
20	26.60	26.90	-	-	-	-	-	-	1.40	1.70	23.65	1.70	2.10	2.10	22.95	-
25	33.40	33.70	-	-	1.40	1.70	30.45	30.45	1.70	2.10	29.75	2.50	3.00	3.00	28.05	-
32	42.10	42.40	-	-	1.70	2.10	38.45	38.45	2.20	2.60	37.45	3.20	3.70	3.20	35.35	-
40	48.10	48.40	1.40	1.70	1.90	2.30	44.05	44.05	2.50	3.00	42.75	3.60	4.20	3.60	40.45	-
50	60.20	60.50	1.60	2.00	2.40	2.80	55.15	55.15	3.10	3.60	53.65	4.60-	5.30	4.60-	50.45	-
65	75.20	75.50	-	-	-	-	-	-	3.90	4.50	66.95	-	-	-	-	-
80	88.70	89.10	2.40	2.80	3.50	4.10	81.30	81.30	4.60	5.30	79.00	-	-	-	-	-
100	114.10	114.50	3.00	3.50	4.50	5.20	104.60	104.60	5.90	6.70	101.70	-	-	-	-	4"
125	140.00	140.40	-	-	5.50	6.30	128.40	128.40	7.20	8.10	124.90	-	-	-	-	5"
150	160.00	160.50	4.20	4.20	6.30	7.10	146.85	146.85	8.30	9.30	142.65	12.00	13.60	12.00	134.65	6"
175	200.00	200.50	-	-	7.10	8.00	185.15	185.15	-	-	-	-	-	-	-	-
177	177.10	177.60	-	-	-	-	-	-	9.20	10.30	157.85	-	-	-	-	7 1/4"
200	225.00	225.60	5.40	6.10	7.90	8.90	208.50	208.50	10.50	11.70	203.10	-	-	-	-	8"
225	250.00	250.70	-	-	-	-	-	-	11.60	13.00	225.75	-	-	-	-	9"
250	280.00	288.80	-	-	-	-	-	-	13.00	14.50	252.90	-	-	-	-	10"
300	315.00	315.90	-	-	-	-	-	-	14.70	16.30	284.45	-	-	-	-	12"

8.2.3 STANDARD PIPE SIZE CHARTS FOR STEEL PIPE

Table A1: Standard ANSI Pipe Size Data for Carbon Steel and Stainless Steel Pipe

Nominal Pipe Size (in)	Outer Diameter (in)	Wall Thickness (in)	ANSI B 36.10 Carbon Steel Wall Thickn.	ANSI B 36.10 Carbon Steel Sch. Number	ANSI B 36.19 Stainless Steel Sch. Number
1/8	0.405	0.049	-	-	10S
		0.068	STD	40	40S
		0.095	XS	80	80S
1/4	0.540	0.065	-	-	10S
		0.088	STD	40	40S
		0.119	XS	80	80S
3/8	0.675	0.065	-	-	10S
		0.091	STD	40	40S
		0.126	XS	80	80S
1/2	0.840	0.065	-	-	5S
		0.083	-	-	10S
		0.109	STD	40	40S
		0.147	XS	80	80S
		0.187	-	160	-
		0.294	XXS	-	-
3/4	1.050	0.065	-	-	5S
		0.083	-	-	10S
		0.113	STD	40	40S
		0.154	XS	80	80S
		0.218	-	160	-
		0.308	XXS	-	-
1	1.315	0.065	-	-	5S
		0.109	-	-	10S
		0.133	STD	40	40S
		0.179	XS	80	80S
		0.250	-	160	-
		0.358	XXS	-	-
1.1/4	1.660	0.065	-	-	5S
		0.109	-	-	10S
		0.140	STD	40	40S
		0.191	XS	80	80S
		0.250	-	160	-
		0.382	XXS	-	-

It continues in the following page

EUROSONIC 2000 HH

It comes from the previous page

Nominal Pipe Size (in)	Outer Diameter (in)	Wall Thickness (in)	ANSI B 36.10 Carbon Steel Wall Thickn.	ANSI B 36.10 Carbon Steel Sch. Number	ANSI B 36.19 Stainless Steel Sch. Number
11/2	1.900	0.065	-	-	5S
		0.109	-	-	10S
		0.145	STD	40	40S
		0.200	XS	80	80S
		0.281	-	160	-
		0.400	XXS	-	-
2	2.375	0.065	-	-	5S
		0.109	-	-	10S
		0.154	STD	40	40S
		0.218	XS	80	80S
		0.344	-	160	-
		0.436	XXS	-	-
2 1/2	2.875	0.083	-	-	5S
		0.120	-	-	10S
		0.203	STD	40	40S
		0.276	XS	80	80S
		0.375	-	160	-
		0.552	XXS	-	-
3	3.500	0.083	-	-	5S
		0.120	-	-	10S
		0.216	STD	40	40S
		0.300	XS	80	80S
		0.438	-	160	-
		0.600	XXS	-	-
3 1/2	4.000	0.083	-	-	5S
		0.120	-	-	10S
		0.226	STD	40	40S
		0.318	XS	80	80S
		0.636	XXS	-	-
		0.083	-	-	5S
4	4.500	0.120	-	-	10S
		0.237	STD	40	40S
		0.337	XS	80	80S
		0.438	-	120	-
		0.531	-	160	-
		0.674	XXS	-	-

It continues in the following page

It comes from the previous page

Nominal Pipe Size (in)	Outer Diameter (in)	Wall Thickness (in)	ANSI B 36.10 Carbon Steel Wall Thickn.	ANSI B 36.10 Carbon Steel Sch. Number	ANSI B 36.19 Stainless Steel Sch. Number
5	5.536	0.109	-	-	5S
		0.134	-	-	10S
		0.258	STD	40	40S
		0.375	XS	80	80S
		0.500	-	120	-
		0.625	-	160	-
		0.750	XXS	-	-
6	6.625	0.109	-	-	5S
		0.134	-	-	10S
		0.280	STD	40	40S
		0.432	XS	80	80S
		0.562	-	120	-
		0.719	-	160	-
		0.864	XXS	-	-
8	8.625	0.109	-	-	5S
		0.148	-	-	10S
		0.250	-	20	-
		0.277	-	30	-
		0.322	STD	40	40S
		0.406	-	60	-
		0.500	XS	80	80S
		0.594	-	100	-
		0.719	-	120	-
		0.812	-	140	-
10	10.750	0.875	XXS	-	-
		0.906	-	160	-
		0.134	-	-	5S
		0.165	-	-	10S
		0.250	-	20	-
		0.307	-	30	-
		0.365	STD	40	40S
		0.500	XS	60	80S
		0.594	-	80	-
		0.719	-	100	-
0.844	-	120	-		
1.000	XXS	140	-		

It continues in the following page

EUROSONIC 2000 HH

It comes from the previous page

Nominal Pipe Size (in)	Outer Diameter (in)	Wall Thickness (in)	ANSI B 36.10 Carbon Steel Wall Thickn.	ANSI B 36.10 Carbon Steel Sch. Number	ANSI B 36.19 Stainless Steel Sch. Number
12	12.750	0.156	-	-	5S
		0.180	-	-	10S
		0.250	-	20	-
		0.330	-	30	-
		0.375	STD	-	40S
		0.406	-	40	-
		0.500	XS	-	80S
		0.562	-	60	-
		0.688	-	80	-
		0.844	-	100	-
		1.000	XXS	120	-
		1.125	-	140	-
		1.312	-	160	-
14	14.000	0.156	-	-	5S
		0.188	-	-	10S
		0.250	-	10	-
		0.312	-	20	-
		0.375	STD	30	-
		0.438	-	40	-
		0.500	XS	-	-
		0.594	-	60	-
		0.625	XXS	-	-
		0.750	-	80	-
		0.938	-	100	-
		1.094	-	120	-
		1.250	-	140	-
1.406	-	160	-		

It continues in the following page

It comes from the previous page

Nominal Pipe Size (in)	Outer Diameter (in)	Wall Thickness (in)	ANSI B 36.10 Carbon Steel Wall Thickn.	ANSI B 36.10 Carbon Steel Sch. Number	ANSI B 36.19 Stainless Steel Sch. Number
16	16.000	0.165	-	-	5S
		0.188	-	-	10S
		0.250	-	10	-
		0.312	-	20	-
		0.375	STD	30	-
		0.500	XS	40	-
		0.656	-	60	-
		0.844	-	80	-
		1.031	-	100	-
		1.219	-	120	-
		1.439	-	140	-
		1.549	-	160	-
18	18.000	0.165	-	-	5S
		0.188	-	-	10S
		0.250	-	10	-
		0.312	-	20	-
		0.375	STD	-	-
		0.438	-	30	-
		0.500	XS	-	-
		0.562	-	40	-
		0.750	-	60	-
		0.938	-	80	-
		1.156	-	100	-
		1.375	-	120	-
1.562	-	140	-		
1.781	-	160	-		

It continues in the following page

EUROSONIC 2000 HH

It comes from the previous page

Nominal Pipe Size (in)	Outer Diameter (in)	Wall Thickness (in)	ANSI B 36.10 Carbon Steel Wall Thickn.	ANSI B 36.10 Carbon Steel Sch. Number	ANSI B 36.19 Stainless Steel Sch. Number
20	20.000	0.188	-	-	5S
		0.218	-	-	10S
		0.250	-	10	-
		0.375	STD	20	-
		0.500	XS	30	-
		0.594	-	40	-
		0.812	-	60	-
		1.031	-	80	-
		1.281	-	100	-
		1.500	-	120	-
		1.750	-	140	-
1.969	-	160	-		
22	22.000	0.188	-	-	5S
		0.218	-	-	10S
		0.250	-	10	-
		0.375	STD	20	-
		0.500	-	40	-
		0.875	-	60	-
		1.125	-	80	-
		1.375	-	100	-
		1.625	-	120	-
		1.875	-	140	-
		2.215	-	160	-
24	24.000	0.218	-	-	5S
		0.250	-	-	10S
		0.375	-	10	-
		0.500	STD	20	-
		0.562	XS	-	-
		0.688	-	30	-
		0.969	-	60	-
		1.219	-	80	-
		1.531	-	100	-
		1.812	-	120	-
		2.062	-	140	-
2.344	-	160	-		

It continues in the following page

It comes from the previous page

Nominal Pipe Size (in)	Outer Diameter (in)	Wall Thickness (in)	ANSI B 36.10 Carbon Steel Wall Thickn.	ANSI B 36.10 Carbon Steel Sch. Number	ANSI B 36.19 Stainless Steel Sch. Number
26	26.000	0.312	-	10	-
		0.375	STD	-	-
		0.500	XS	20	-
28	28.000	0.312	-	10	-
		0.375	STD	-	-
		0.500	XS	20	-
30	30.000	0.625	-	30	-
		0.250	-	-	5S
		0.312	-	10	10S
30	30.000	0.375	STD	-	-
		0.500	XS	20	-
		0.625	-	30	-
		0.750	-	40	-
		0.312	-	10	-
32	32.000	0.375	STD	-	-
		0.500	XS	20	-
		0.625	-	30	-
		0.688	-	40	-
34	34.000	0.344	-	10	10S
		0.375	STD	-	-
		0.500	XS	20	-
		0.625	-	30	-
		0.688	-	40	-
36	36.000	0.312	-	10	10S
		0.375	STD	-	-
		0.500	XS	20	-
		0.625	-	30	-
		0.750	-	40	-
42	42.000	0.375	STD	-	-
		0.500	XS	20	-
		0.625	-	30	-
		0.750	-	40	-
48	48.000	0.375	STD	-	-
		0.500	XS	-	-

8.2.4 STANDARD PIPE SIZE CHARTS FOR CAST IRON PIPE

Table A2: Standard Classes of Cast Iron Pipe

Nominal Pipe Size (in)	Class A		Class B		Class C		Class D	
	Outer Diameter	Wall Thickness	Outer Diameter	Wall Thickness	Outer Diameter	Wall Thickness	Outer Diameter	Wall Thickness
3	3.80	0.39	3.96	0.42	3.96	0.45	3.96	0.48
4	4.80	0.42	5.00	0.45	5.00	0.48	5.00	0.52
6	6.90	0.44	7.10	0.48	7.10	0.51	7.10	0.55
8	9.05	0.46	9.05	0.51	9.30	0.56	9.30	0.60
10	11.10	0.50	11.10	0.57	11.40	0.62	11.40	0.68
12	13.20	0.54	13.20	0.62	13.50	0.68	13.50	0.75
14	15.30	0.57	15.30	0.66	15.65	0.74	15.65	0.82
16	7.40	0.60	17.40	0.70	17.80	0.80	17.80	0.89
18	19.50	0.64	19.50	0.75	19.92	0.87	19.92	0.96
20	21.60	0.67	21.60	0.80	22.06	0.92	22.06	1.03
24	25.80	0.76	25.80	0.89	26.32	1.05	26.32	1.16
30	31.74	0.88	32.00	1.03	32.40	1.20	32.74	1.37
32	37.96	0.99	38.30	1.15	38.70	1.36	39.16	1.58
42	44.20	1.10	44.50	1.28	45.10	1.54	45.58	1.78
48	50.50	1.26	50.80	1.42	51.40	1.71	51.98	1.99
54	56.66	1.35	57.10	1.55	57.80	1.90	58.40	2.23
60	62.80	1.39	63.40	1.67	64.20	2.00	64.82	2.38
72	75.34	1.62	76.00	1.95	76.88	2.39		
84	87.54	1.72	88.54	2.22				

Nominal Pipe Size (in)	Class E		Class F		Class G		Class H	
	Outer Diameter	Wall Thickness	Outer Diameter	Wall Thickness	Outer Diameter	Wall Thickness	Outer Diameter	Wall Thickness
6	7.22	0.58	7.22	0.61	7.38	0.65	7.38	0.69
8	9.42	0.66	9.42	0.66	9.60	0.75	9.60	0.80
10	11.60	0.74	11.60	0.80	11.84	0.86	11.84	0.92
12	13.78	0.82	13.78	0.89	14.08	0.97	14.08	1.04
14	15.98	0.90	15.98	0.99	16.32	1.07	16.32	1.16
16	18.16	0.90	18.16	1.08	18.54	1.18	18.54	1.27
18	20.34	1.07	20.34	1.17	20.78	1.28	20.78	1.39
20	22.54	1.15	22.54	1.27	23.02	1.39	23.02	1.51
24	26.90	1.31	26.90	1.45	27.76	1.75	27.76	1.88
30	33.10	1.55	33.46	1.73				
32	39.60	1.80	40.04	2.02				

8.2.5 STANDARD PIPE SIZE CHARTS FOR DUCTILE IRON PIPE

Table A3: Standard Classes of Ductile Iron Pipe

Nominal Pipe Size (in)	Outer Diameter (in)	Pipe Wall Thickness (in)						
		Class 50	Class 51	Class 52	Class 53	Class 54	Class 55	Class 56
3	3.96		0.25	0.28	0.31	0.43	0.37	0.40
4	4.80		0.26	0.29	0.32	0.35	0.38	0.41
6	6.90	0.25	0.28	0.31	0.34	0.37	0.40	0.43
8	9.05	0.27	0.30	0.33	0.36	0.39	0.42	0.45
10	11.10	0.29	0.32	0.35	0.38	0.44	0.47	
12	13.20	0.31	0.34	0.37	0.40	0.43	0.46	0.49
14	15.30	0.33	0.36	0.39	0.42	0.45	0.48	0.51
16	17.40	0.34	0.37	0.40	0.43	0.46	0.49	0.52
18	19.50	0.35	0.38	0.41	0.44	0.47	0.50	0.53
20	21.60	0.36	0.39	0.42	0.45	0.48	0.51	0.54
24	25.80	0.38	0.41	0.44	0.47	0.50	0.53	0.56
30	32.00				0.51	0.55	0.59	0.63
32	38.30				0.58	0.63	0.68	0.73
42	44.50				0.65	0.71	0.77	0.83
48	50.80				0.72	0.79	0.86	0.93
54	57.10				0.81	0.89	0.97	1.05

8.3 SOUND SPEED TABLES

8.3.1 SOUND SPEED DATA OF SOLIDS

Table A4: Sound Speed data of solids

Material	Sound Speed		Sound Speed	
	Shear Wave (25(d))		Long. Wave (25(d))	
	m/s	ft/s	mm/us	in/us
Steel, 1% Carbon, hardened	3,150	10,335	5.88	0.2315
Carbon Steel	3,230	10,598	5.89	0.2319
Mild Steel	3,235	10,614	5.89	0.2319
Steel, 1% Carbon	3,220	10,565		
302 Stainless Steel	3,120	10,236	5.690	0.224
303 Stainless Steel	3,120	10,236	5.640	0.222
304 Stainless Steel	3,141	10,306	5.920	0.233
304L Stainless Steel	3,070	10,073	5.790	0.228
316 Stainless Steel	3,272	10,735	5.720	0.225
347 Stainless Steel	3,095	10,512	5.720	0.225
Aluminum	3,100	10,171	6.32	0.2488
Aluminum (rolled)	3,040	9,974		
Copper	2,260	7,415	4.66	0.1835
Copper (annealed)	2,235	7,628		
Copper (rolled)	2,270	7,448		
CuNi (70%Cu 30%Ni)	2,540	8,334	5.03	0.1980
CuNi (90%Cu 10%Ni)	2,060	6,759	4.01	0.1579
Brass (Naval)	2,120	6,923	4.43	0.1744
Gold (hard-drawn)	1,200	3,937	3.24	0.1276
Inconel	3,020	9,909	5.82	0.2291
Iron (electrolytic)	3,240	10,630	5.90	0.2323
Iron (Armco)	3,240	10,630	5.90	0.2323
Ductile Iron	3,000	9,843		
Cast Iron	2,500	8,203	4.55	0.1791
Monel	2,720	8,924	5.35	0.2106
Nickel	2,960	9,712	5.63	0.2217
Tin, rolled	1,670	5,479	3.32	0.1307
Titanium	3,125	10,253	6.10	0.2402
Tungsten, annealed	2,890	9,482	5.18	0.2039
Tungsten, drawn	2,640	8,661		
Tungsten, carbide	3,980	13,058		
Zinc, rolled	2,440	8,005	4.17	0.1642

It continues in the following page

It comes from the previous page

Material	Sound Speed		Sound Speed	
	Shear Wave (25(d))		Long. Wave (25(d))	
	m/s	ft/s	mm/us	in/us
Glass,Pyrex	3,280	10,761	5.61	0.2209
Glass,heavy silicate flint	2,380	7,808		
Glass,light borate crown	2,840	9,318	5.26	0.2071
Nylon	1,150	3,772	2.40	0.0945
Nylon,6-6	1,070	3,510		
Polyethylene (LD)			2.31	0.0909
Polyethylene (LD)	540	1,772	1.94	0.0764
PVC,CPVC	1,060	3,477	2.40	0.0945
Acrylic	1,430	4,690	2.73	0.1075
Asbestos Cement			2.20	0.0866
Tar Epoxy			2.00	0.0787
Mortar			2.50	0.0984
Rubber			1.90	0.00748

8.3.2 SOUND SPEED IN WATER**Table A5: Sound Speed in Water at atmosphere pressure. Unit T (Deg C) V (m/s)**

t	v	t	v	t	v	t	v
0	1402.3	25	1496.6	50	1542.5	75	1555.1
1	1407.3	26	1499.2	51	1543.5	76	1555.0
2	1412.2	27	1501.8	52	1544.6	77	1554.9
3	1416.9	28	1504.3	53	1545.5	78	1554.8
4	1421.6	29	1506.7	54	1546.4	79	1554.6
5	1426.1	30	1509.0	55	1547.3	80	1554.4
6	1430.5	31	1511.3	56	1548.1	81	1554.2
7	1434.8	32	1513.5	57	1548.9	82	1553.9
8	1439.1	33	1515.7	58	1549.6	83	1553.6
9	1443.2	34	1517.7	59	1550.3	84	1553.2
10	1447.2	35	1519.7	60	1550.9	85	1552.8
11	1451.1	36	1521.7	61	1551.5	86	1552.4
12	1454.9	37	1523.5	62	1552.0	87	1552.0
13	1458.7	38	1525.3	63	1552.5	88	1551.5
14	1462.3	39	1527.1	64	1553.0	89	1551.0
15	1465.8	40	1528.8	65	1553.4	90	1550.4
16	1469.3	41	1530.4	66	1553.7	91	1549.8
17	1472.7	42	1532.0	67	1554.0	92	1549.2
18	1476.0	43	1533.5	68	1554.3	93	1548.5
19	1479.1	44	1534.9	69	1554.5	94	1547.5
20	1482.3	45	1536.3	70	1554.7	95	1547.1
21	1485.3	46	1537.7	71	1554.9	96	1546.3
22	1488.2	47	1538.9	72	1555.0	97	1545.6
23	1491.1	48	1540.2	73	1555.0	98	1544.7
24	1493.9	49	1541.3	74	1555.1	99	1543.9

8.3.3 SOUND SPEED IN LIQUIDS

Table A6: Sound Speed in Liquids

Substance	Chemical Formula	All data given at 25°C (77°F) unless otherwise noted.					
		Specific Gravity	Sound Speed		v/°C m/s/°C	Kinematic Viscosity x10 ⁻⁶	
			m/s	ft/s		m ² /s	ft ² /s
Acetic anhydride(22)	(CH ₃ CO) ₂ O	1.082 (20 °C)	1,180	3,871.4	2.5	0.769	8.274
Acetic acid,anhydride(22)	(CH ₃ CO) ₂ O	1.082 (20 °C)	1,180	3,871.4	2.5	0.769	8.274
Acetic acid,nitrile	C ₂ H ₃ N	0.783	1,290	4,232.3	4.1	0.441	4.745
Acetic acid,ethyl ester(33)	C ₄ H ₈ O ₂	0.901	1,085	3,559.7	4.4	0.467	5.025
Acetic acid,methyl ester	C ₃ H ₆ O ₂	0.934	1,211	3,973.1		0.407	4.379
Acetone	C ₃ H ₆ O	0.791	1,174	3,851.7	4.5	0.399	4.293
Acetonitrile	C ₂ H ₃ N	0.783	1,290	4,232.3	4.1	0.441	4.745
Acetylacetone	C ₆ H ₁₀ O ₂	0.729	1,399	4,589.9	3.6		
Acetylen dichloride	C ₂ H ₂ CL ₂	1.26	1,015	3,330.1	3.8	0.400	4.304
Acetylen tetrabromide(47)	C ₂ H ₂ Br ₄	2.966	1,027	3,369.4			
Acetylen tetrachloride(47)	C ₂ H ₂ CL ₄	1.595	1,147	3,763.1		1.156 (15 °C)	12.438 (59°F)
Alcohol	C ₂ H ₆ O	0.789	1,207	3,960	4.0	1.396	15.02
Alkazene-13	C ₁₅ H ₂₄	0.86	1,317	4,320.9	3.9		
Alkazene-25	C ₁₀ H ₁₂ CL ₂	1.20	1,307	4,288.1	3.4		
2-Amino-ethanol	C ₂ H ₇ NO	1.018	1,724	5,656.2	3.4		
2-Aminotolidine(46)	C ₇ H ₉ N	0.999 (20 °C)	1,618	5,308.4		4.394 (20 °C)	47.279 (68°F)
4-Aminotolidine(46)	C ₇ H ₉ N	0.999 (45 °C)	1,480	4,855.6		1.863 (50 °C)	20.045 (122°F)

It continues in the following page

EUROSONIC 2000 HH

It comes from the previous page

Substance	Chemical Formula	All data given at 25°C (77°F) unless otherwise noted.					
		Specific Gravity	Sound Speed		v/°C m/s/°C	Kinematic Viscosity x10 ⁻⁶	
			m/s	ft/s		m ² /s	ft ² /s
Ammonia(35)	NH ₃	0.771	1,729 (-33 °C) (d)	5,672.6 (-27°F)	6.68	0.292 (-33 °C)	3.141 (-27°F)
Amorphous Polyolefin		0.98	962.6 (190 °C)	3158.2 (374°F)		26,600	286.000
t-Amyl alcohol	C ₅ H ₁₂ O	0.81	1,204	3,950.1		4.374	47.064
Aminobenzene(41)	C ₆ H ₅ NO ₂	1.022	1,639	5,377.3	4.0	3.63	39.058
Aniline(41)	C ₆ H ₅ NO ₂	1.022	1,639	5,377.3	4.0	3.63	39.058
Argon(45)	Ar	1.400 (-188 °C)	853 (-188 °C)	2798.6 (-306°F)			
Azine	C ₆ H ₅ N	0.982	1,415	4,642.4	4.1	0.992 (20°C)	10.673 (68°F)
Benzene(29,40,41)	C ₆ H ₆	0.879	1,306	4,284.8	4.65	0.711	7.65
Benzol(29,40,41)	C ₆ H ₆	0.879	1,306	4,284.8	4.65	0.711	7.65
Bromine(21)	Br ₂	2.928	889	2,916.7	3.0	0.323	3.475
Bromo-benzene(46)	C ₆ H ₅ Br	1.522	1,170 (20°C)	3,838.6 (68°F)		0.693	7.456
1-Bromo-butane(46)	C ₄ H ₉ Br	1.276 (20°C)	1,019 (20°C)	3,343.2 (68°F)		0.49 (15°C)	5.272 (59°F)
Bromo-ethane(46)	C ₂ H ₅ Br	1.460 (20°C)	900 (20°C)	2,952.8 (68°F)		0.275	2.959
Bromoform(46,47)	CHBr ₃	2.89 (20°C)	918	3,011.8	3.1	0.654	7.037
n-Butane(2)	C ₄ H ₁₀	0.601 (0°C)	1,085 (-5°C)	3,559.7 (23°F)	5.8		
2-Butanol	C ₄ H ₁₀ O	0.81	1,240	4,068.2	3.3	3.239	34.851
Sec-Butylalcohol	C ₄ H ₁₀ O	0.81	1,240	4,068.2	3.3	3.239	34.851
n-Butyl bromide(46)	C ₄ H ₉ Br	1.276 (20°C)	1,019 (20°C)	3,343.2 (68°F)		0.49 (15°C)	5.272 (59°F)

It continues in the following page

It comes from the previous page

Substance	Chemical Formula	All data given at 25°C (77°F) unless otherwise noted.					
		Specific Gravity	Sound Speed		v/°C m/s/°C	Kinematic Viscosity x10 ⁻⁶	
			m/s	ft/s		m ² /s	ft ² /s
n-Butyl chloride(22,46)	C ₄ H ₉ CL	0.887	1,140	3,740.2	4.57	0.529 (15°C)	5.692 (59°F)
Tert Butyl chloride	C ₄ H ₉ CL	0.84	984	3,228.3	4.2	0.646	6.95
Butyl oleate	C ₂₂ H ₄₂ O ₂		1,404	4,606.3	3.0		
2,3 Butylene glycol	C ₄ H ₁₀ O ₂	1.019	1,484	4,808.8	1.51		
Cadmium(7)	CD		2,237.7 (400°C)	7,341.5 (752°F)		1.355cp (440°C)	14.579 (824°F)
Carbinol(40,41)	CH ₄ O	0.791 (20°C)	1,076	3,530.2	2.92	0.695	7.478
Carbitol	C ₆ H ₁₄ O ₃	0.988	1,458	4,783.5			
Carbon dioxide(26)	CO ₂	1.101 (-37°C)	839 (-37°C)	2,752.6 (-35°F)	7.71	0.137 (-37°C)	1.474 (-35°F)
Carbon disulphide	CS ₂	1.261 (22°C)	1,149	3,769.7		0.278	2.991
Carbon tetrachloride (33,35,47)	CCL ₄	1.595 (20°C)	929	3038.1	2.48	0.607	6.531
Carbon tetrafluoride(14) (Freon 14)	CF ₄	1.75 (-150°C)	875.2 (-150°C)	2,871.5 (-238°F)	6.61		
Cetane(23)	C ₁₆ H ₃₄	0.773 (20°C)	1,338	4,389.8	3.71	4.32	46.483
Chloro-benezene	C ₆ H ₅ CL	1.106	1,273	4,176.5	3.6	0.722	7.768
1-Chloro-butane(22,46)	C ₄ H ₉ CL	0.887	1,140	3,740.2	4.57	0.529 (15°C)	5.692 (59°F)
Chloro-diFluoromethane (3)(Freon 22)	CHCLF ₂	1.491 (-69°C)	893.9 (-50°C)	2,932.7 (-58°F)	4.79		
Chloroform(47)	CHCL ₃	1.489	979	3,211.9	3.4	0.55	5.918
1-Chloro-propane(47)	C ₃ H ₇ CL	0.892	1,058	3,471.1		0.378	4.067
Chlorotrifluoromethane (5)	CCLF ₃		724 (-82°C)	2,375.3 (-116°F)	5.26		

It continues in the following page

It comes from the previous page

Substance	Chemical Formula	All data given at 25°C (77°F) unless otherwise noted.					
		Specific Gravity	Sound Speed		v/°C m/s/°C	Kinematic Viscosity x10 ⁻⁶	
			m/s	ft/s		m ² /s	ft ² /s
Cinnamaldehyde	C ₉ H ₈ O	1.112	1,554	5,098.4	3.2		
Cinnamic aldehyde	C ₉ H ₈ O	1.112	1,554	5,098.4	3.2		
Colamine	C ₂ H ₇ NO	1.018	1,724	5,656.2	3.4		
o-Cresol(46)	C ₇ H ₈ O	1.047 (20°C)	1,541 (20°C)	5,055.8 (68°F)		4.29 (40°C)	46.16 (104°F)
m-Cresol(46)	C ₇ H ₈ O	1.034 (20°C)	1,500 (20°C)	4,923.1 (68°F)		5.979 (40°C)	64.334 (104°F)
Cyanomethane	C ₂ H ₃ N	0.783	1,290	4,232.3	4.1	0.441	4.745
Cyclohexane(15)	C ₆ H ₁₂	0.779 (20°C)	1,248	4,094.5	5.41	1.31 (17°C)	14.095 (63°F)
Cyclohexanol	C ₆ H ₁₂ O	0.962	1,454	4,770.3	3.6	0.071 (17(d))	0.764 (63°F)
Cyclohexanone	C ₆ H ₁₀ O	0.948	1,423	4,668.6	4.0		
Decane(46)	C ₁₀ H ₂₀	0.730	1,252	4,107.6		1.26 (20°C)	13.55 (68°F)
1-Decene(27)	C ₁₀ H ₂₀	0.746	1,235	4,051.8	4.0		
n-Decene(27)	C ₁₀ H ₂₀	0.746	1,235	4,051.8	4.0		
Diacetyl	C ₄ H ₆ O	0.99	1,236	4,055.1	4.6		
Diamylamine	C ₁₀ H ₂₃ N		1,256	4,120.7	3.9		8.5 (68°F)
1,2Dibromo-ethane(47)	C ₂ H ₄ Br ₂	2.18	995	3,264.4		0.79 (20°C)	
trans-1,2-Dibromoethene (47)	C ₂ H ₂ Br ₂	2.231	935	3,067.6			
Dibutylphthalate	C ₈ H ₂₂ O ₄		1,408	4,619.4			
Dichloro-t-butylalcohol	C ₄ H ₈ Cl ₂ O		1,304	4,278.2	3.8		

It continues in the following page

It comes from the previous page

Substance	Chemical Formula	All data given at 25°C (77°F) unless otherwise noted.					
		Specific Gravity	Sound Speed		v/°C m/s/°C	Kinematic Viscosity x10 ⁻⁶	
			m/s	ft/s		m ² /s	ft ² /s
2,3Dichlorodioxane	C ₂ H ₆ Cl ₂ O ₂		1,391	4,563.6	3.7		
Dichloedifluoromethane (3)(Freon12)	CCl ₂ F ₂	1.516 (40°C)	774.1	2,539.7	4.24		
1,2Dichloro ethane(47)	C ₂ H ₂ Cl ₂	1.253	1,193	3,914		0.61	6.563
cis1,2-Dichloro-ethene (3,47)	CHCl ₂ F	1.284	1,061	3,481			
trans1,2-Dichloro-ethene (3,47)	C ₄ Cl ₂ F ₆	1.257	1,010	3,313.6			
Dichloro-fluoromethane (3)(Freon21)	C ₄ H ₈ Cl ₂	1.426 (0°C)	891 (0°C)	2,923.2 (32°F)	3.97		
1-2-Dichlorohexafluoro- cyclobutane(47)	CClF ₂ -CClF ₂	1.654	669	2,914.9			
1-3-Dichloro-isobutane	C ₄ H ₁₀ O	1.14	1,220	4,002.6	3.4		
Dichloro methane(3)	C ₄ H ₁₀ O ₃	1.327	1,070	3,510.5	3.94	0.31	3.335
1,1-Dichloro-1,2,2,2 tetra fluoromethane	C ₆ H ₁₄ O ₃	1.455	665.3 (-10°C)	2,182.7 (14°F)	3.73		
Diethyl ether	C ₄ H ₉ NO	0.713	985	3,231.6	4.87	0.311	3.346
Diethylene glycol	C ₄ H ₈ (NF ₂) ₂	1.116	1,586	5,203.4	2.4		
Diethylene glycol Monoethyl ether	C ₄ H ₉ (NF ₂) ₂	0.988	1,458	4,783.5			
Diethylenimide oxide	C ₃ H ₆ (NF ₂) ₂	1.00	1,442	4,731	3.8		
1,2-bis(DiFluoramino) butane(43)	C ₁₀ H ₂₃ N	1.216	1,000	3,280.8			
1,2-bis(DiFluoramino)- 2-methylpropane(43)	C ₂ H ₄ Br ₂	1.213	900	2,952.8			
1,2-bis(DiFluoramino) propane(43)	C ₂ H ₂ Br ₂	1.265	960	3,149.6			
2,2-bis(Difluoromino propane(43)	C ₃ H ₆ (NF ₂) ₂	1.254	890	2920			

It continues in the following page

It comes from the previous page

Substance	Chemical Formula	All data given at 25°C (77°F) unless otherwise noted.					
		Specific Gravity	Sound Speed		v/°C	Kinematic Viscosity x10 ⁻⁶	
			m/s	ft/s	m/s/°C	m ² /s	ft ² /s
2,2-Dihydroxydiethyl ether	C ₄ H ₁₀ O ₃	1.116	1,586	5,2034	2.4		
Dihydroxyethane	C ₂ H ₆ O ₂	1.113	1,658	5,439.6	2.1		
1,3-Dimethyl-benzene(46)	C ₈ H ₁₀	0.868 (15°C)	1,343 (20°C)	4,406.2 (68°F)		0.749 (15°C)	8.059 (59°F)
1,2-Dimethyl-benzene (29,46)	C ₈ H ₁₀	0.897 (20°C)	1,331.5	4,368.4	4.1	0.903 (20°C)	9.716 (68°F)
1,4-Dimethyl-benzene(46)	C ₈ H ₁₀		1,334 (20°C)	4,376.6 (68°F)		0.662	7.123
2,2Dimethyl-butane (29,33)	C ₆ H ₁₄	0.649 (20°C)	1,079	3,540			
Dimethyl ketone	C ₃ H ₆ O	0.791	1,174	3,851.7	4.5	0.399	4.293
Dimethylpentane(47)	C ₇ H ₁₆	0.674	1,063	3,487.5			
Dimethylphthalate	C ₈ H ₁₀ O ₄	1.2	1,463	4,799.9			
Diiodo-methane	CH ₂ I ₂	3.235	980	3,215.2			
Dioxane	C ₄ H ₈ O ₂	1.033	1,376	4,514.4			
Dodecane(23)	Cl ₂ H ₂₆	0.749	1,279	4,196.2	3.85	1.80	19.368
1,2Ethanediol	C ₂ H ₆ O ₂	1.113	1,658	5,439.6	2.1		
Ethanenitrile	C ₂ H ₃ N	0.783	1,290	4,232.3		0.441	4.745
Ethanoic anhydride(22)	(CH ₃ CO) ₂ O	1.082	1,180	3,871.4		0.769	8.274
Ethanol	C ₂ H ₆ O	0.789	1,207	3,690	4.0	1.39	14.956
Ethanol amide	C ₂ HNO	1.018	1,338 (20°C)	5,656.2	3.4		
Ethoxyethane	C ₄ H ₁₀ O	0.713	900 (20°C)	3,231.6	4.87	0.311	3.346

It continues in the following page

It comes from the previous page

Substance	Chemical Formula	All data given at 25°C (77°F) unless otherwise noted.					
		Specific Gravity	Sound Speed		v/°C m/s/°C	Kinematic Viscosity x10 ⁻⁶	
			m/s	ft/s		m ² /s	ft ² /s
Ethyl acetate(33)	C ₄ H ₈ O ₂	0.901	876 (20°C)	3,559.7	4.4	0.489	5.263
Ethyl alcohol	C ₂ H ₆ O	0.789	890	3,960	4.0	1.396	15.020
Ethyl benzene(46)	C ₈ H ₁₀	0.867 (20°C)	1,586	4,389.8 (68°F)		0.797 (17°C)	8.575 (63°F)
Ethyl Bromide(46)	C ₂ H ₅ Br	1.456 (20°C)	1,658	2,952.8 (68°F)		0.275 (20°C)	2.959 (68°F)
Ethyl iodide(46)	C ₂ H ₅ I	1.950 (20°C)	1,343 (20°C)	2874 (68°F)		0.29	3.12
Ether	C ₄ H ₁₀ O	0.713	985	3231.6	4.87	0.311	3.346
Ethyl ether	C ₄ H ₁₀ O	0.713	985	3231.6	4.87	0.311	3.346
Ethylene bromide(47)	C ₂ H ₄ Br ₂	2.18	995	3264.4		0.79	8.5
Ethylene chloride(47)	C ₂ H ₄ Cl ₂	1.253	1,193	3914		0.61	6.563
Ethylene glycol	C ₂ H ₆ O ₂	1.113	1,658	5439.6	2.1	17.208 (20°C)	185.158 (68°F)
d-Fenochone	C ₁₀ H ₁₆ O	0.974	1,320	4330.7		0.22	2.367
d-2-Fenecanone	C ₁₀ H ₁₆ O	0.974	1,320	4330.7		0.22	2.367
Fluorine	F	0.545 (-143°C)	403 (-143(d))	1322.2 (-225°F)	11.31		
Fluoro-benzene(46)	C ₆ H ₅ F	1.024 (20°C)	1,189	3900.9		0.584 (20°C)	6.283 (68°F)
Formaldehyde,methylester	C ₂ H ₄ O ₂	0.974	1,127	3697.5	4.02		
Formamide	CH ₃ NO	1.134 (20°C)	1,622	5321.5	2.2	2.91	31.311
Formic acid,amide	CH ₃ NO	1.134 (20°C)	1,622	5321.5		2.91	31.311
Freon R12			774.2	2540			

It continues in the following page

EUROSONIC 2000 HH

It comes from the previous page

Substance	Chemical Formula	All data given at 25°C (77°F) unless otherwise noted.					
		Specific Gravity	Sound Speed		v/°C	Kinematic Viscosity x10 ⁻⁶	
			m/s	ft/s	m/s/°C	m ² /s	ft ² /s
Furfural	C ₅ H ₄ O ₂	1.157	1,444	4737.5	3.7		
Furfuryl alcohol	C ₅ H ₆ O ₂	1.135	1,450	4757.5	3.4		
Fural	C ₅ H ₄ O ₂	1.157	1,444	4737.5	3.7		
2-Furaldehyde	C ₅ H ₄ O ₂	1.157	1,444	4737.5	3.7		
2-Furancarboxaldehyde	C ₅ H ₄ O ₂	1.157	1,444	4737.5	3.7		
2-Furyl-Methanol	C ₅ H ₆ O ₂	1.135	1,450	4757.2	3.4		
GAllium	Ga	6.095	2,870 (30°C)	9416 (86°F)			
Glycerin	C ₃ H ₈ O ₃	1.26	1,904	6246.7	2.2	757.1	
Glycerol	C ₃ H ₈ O ₃	1.26	1,904	6246.7	2.2	757.1	
Glycol	C ₂ H ₆ O ₂	1.113	1658	5439.6	2.1		8,081.836
50%Glycol/50%h2O			1,578	5,177			8,081.836
Helium(45)	He ₄	0.125 (-269°C)	183 (-269°C)	600.4 (-452°F)		0.025	269
Heptane(22,23)	C ₇ H ₁₆	0.684 (209°C)	1,131	3,710.6	4.25	0.598 (209°C)	6.434 (68°F)
n-Heptane(29,33)	C ₇ H ₁₆	0.684 (20°C)	1,180	3,871.3	4.0		
Hexachloro-Cyclopentadiene(47)	C ₅ Cl ₆	1.7180	1,150	3,773			
Hexadecane(23)	C ₁₆ H ₃₄	0.773 (20°C)	1,338	4,389.8	3.71	4.32 (20°C)	46.483 (68°F)
Hexalin	C ₆ H ₁₂ O	0.962	1,454	4,770.3	3.6	70.69 (17°C)	760.882 (63°F)
Hexane(16,22,23)	C ₆ H ₁₄	0.659	1,112	3,648.3	2.71	0.446	4.798

It continues in the following page

It comes from the previous page

Substance	Chemical Formula	All data given at 25°C (77°F) unless otherwise noted.					
		Specific Gravity	Sound Speed		v/°C m/s/°C	Kinematic Viscosity x10 ⁻⁶	
			m/s	ft/s		m ² /s	ft ² /s
n-Hexane(29,33)	C ₆ H ₁₄	0.649 (20°C)	1,079	3,540	4.53		
2,5Hexanedione	C ₆ H ₁₀ O ₂	0.729	1,399	4,589.9	3.6		
n-Hexanol	C ₆ H ₁₄ O	0.819	1,300	4,265.1	3.8		
Hexahydrobenzene(15)	C ₆ H ₁₂	0.779	1,248	4,094.5	5.41	1.31 (179°C)	14.095 (63°F)
Hexahydrophenol	C ₆ H ₁₂ O	0.962	1,454	4,770.3			
Hexamethylene(15)	C ₆ H ₁₂	0.779	1,248	4,094.5		1.31 (17°C)	14.095 (63°F)
Hydrogen(45)	H ₂	0.071 (-256°C)	1,187 (-256°C)	3,894.4 (-429°F)		0.003 (-256°C)	0.032 (-429°F)
2-Hydroxy-toluene(46)	C ₇ H ₈ O	1.047 (20°C)	1,541 (20°C)	5,055.8 (68°F)		4.29 (40°C)	46.16 (104°F)
3-Hydroxy-toluene(46)	C ₆ H ₅ l	1.034 (20°C)	1,500 (20°C)	4,921.3 (68°F)		5.979 (40°C)	64.334 (104°F)
Iodo-benzene(46)	C ₂ H ₅ l	1.823	1,114 (20(d))	3,654.9 (68°F)		0.954	
Iodo-ethane(46)	CH ₃ l	1.950 (20°C)	876 (20°C)	2,874 (68°F)		0.29	3.12
Iodo-methane	C ₆ H ₁₂ O	2.28 (20°C)	978	3,208.7		0.211	2.27
isobutylacetate(22)	He ₄		1,180 (27°C)	3,871.4 (81°F)	4.85		
Isobutanol	C ₄ H ₁₀ O	0.81 (20°C)	1,212	3,976.4			
Iso-Butane			1,219.8	4002			
Isopentane(36)	C ₅ H ₁₂	0.62 (20°C)	980	3,215.2	4.8	0.34	3.658
Isopropano(46)	C ₃ H ₈ O	0.758 (20°C)	1,170 (20°C)	3,838.6 (68°F)		2.718	29.245
Isopropyl alcohol(46)	C ₃ H ₈ O	0.758 (20°C)	1,170 (20°C)	3,838.6 (68°F)		2.718	29.245

It continues in the following page

EUROSONIC 2000 HH

It comes from the previous page

Substance	Chemical Formula	All data given at 25°C (77°F) unless otherwise noted.					
		Specific Gravity	Sound Speed		v/°C m/s/°C	Kinematic Viscosity x10 ⁻⁶	
			m/s	ft/s		m ² /s	ft ² /s
Kerosene		0.81	1,324	4,343.8	3.6		
Ketohexamethylene	C ₆ H ₁₀ O	0.948	1,423	4,668.6	4.0		
Lithium fluoride(42)	LiF		2,485 (900°C)	8,152.9 (1652°F)	1.29		
Mercury(45)	Hg	13.594	1,449 (24°C)	4,753.9 (75°F)		0.114	1.226
Mesityloxide	C ₆ H ₁₆ O	0.85	1,310	4,297.9			
Methane(25,28,38,39)	CH ₄	0.162 (-89°C)	405 (-89°C)	1,328.7 (-128°F)	17.5		
Methano(40,41)	CH ₄ O	0.791 (20°C)	1,076	3,530.2	2.92	0.695	7.748
Methyl acetate	C ₃ H ₆ O ₂	0.934	1,211	3,973.1		0.407	4.379
o-Methyaniline(46)	C ₇ H ₉ N	0.999 (20°C)	1,618	5,308.4		4.394 (20°C)	47.279 (68°F)
4-Methyaniline(46)	C ₇ H ₉ N	0.966 (45(d))	1,480	4,855.6		1.863 (50°C)	20.095 (122°F)
Methyl alcohol(40,44)	CH ₄ O	0.791 (20(d))	1,076	3,530.2	2.92	0.695	7.478
Methyl benzene(16,52)	C ₇ H ₈	0.867	1,328 (20°C)	4,357 (68°F)	4.27	0.644	7.144
2-Methyl-butane(36)	C ₅ H ₁₂	0.62 (20°C)	980	3,215.2		0.34	3.658
Methy carbinol	C ₂ H ₆ O	0.789	1,207	3,960	4.0	1.396	
Methy-chloroform(47)	C ₂ H ₃ Cl ₃	1.33	985	3,231.6		0.902 (20°C)	9.705 (68°F)
Methyl-cyanide	C ₂ H ₃ N	0.783	1,290	4,232.3		0.441	4.745
3-Methyl cyclohexanol	C ₇ H ₁₄ O	0.92	1,400	4,593.2			
Oil,Diesel		0.80	1,250	4,101			

It continues in the following page

It comes from the previous page

Substance	Chemical Formula	All data given at 25°C (77°F) unless otherwise noted.					
		Specific Gravity	Sound Speed		v/°C m/s/°C	Kinematic Viscosity x10 ⁻⁶	
			m/s	ft/s		m ² /s	ft ² /s
Oil,FueiAA gravity		0.99	1,485	4,872	3.7		
Oil(Lubricating x200)			1,530	5,019.9			
Oil(Olive)		0.912	1,431	4,694.9	2.75	100	1,076.36
Oil(peanut)		0.936	1,458	4,783.5			
Oil(Sperm)		0.88	1,440	4,724.2			
Oil,6			1,509 (22°C)	4,951 (72°F)			
2,2-Oxydiethanol	CH ₁₀ O ₃	1.116	1,586	5,203.4	2.4		
Oxygen(45)	O ₂	1.155 (-186°C)	952 (-186°C)	3,123.4 (-303°F)		0.173	1.861
Pentachloro-ethane(47)	C ₂ HCl ₅	1.687	1,082	3,549.4			
pentalin(47)	C ₂ HCl ₅	1.687	1,082	3,549.4			
Pentane(36)	C ₅ H ₁₂	0.626 (20°C)	1,020	3,346.5		0.363	3.905
n-pentane(47)	C ₅ H ₁₂	0.557	1,006	3,300.5		0.41	4.413
Perchlorocyclopentadiene (47)	C ₅ Cl ₆	1.718	1,150	3,773			
Perchloro-ethylene(47)	C ₂ Cl ₄	1.632	1,036	3,399			
Perfluoro-1-Hepten(47)	C ₇ F ₁₄	1.67	583	1,912.7			
Perfluoro-n-Hexane(47)	C ₆ H ₁₄	1.672	508	1,666.7			
Phene(29,40,41)	C ₆ H ₆	0.879	1,306	4,284.8	4.65	0.711	7.65
b-Phenyl acrolein	C ₉ H ₈ O	1.112	1,554	5,098.4	3.2		

It continues in the following page

It comes from the previous page

Substance	Chemical Formula	All data given at 25°C (77°F) unless otherwise noted.					
		Specific Gravity	Sound Speed		v/°C	Kinematic Viscosity x10 ⁻⁶	
			m/s	ft/s	m/s/°C	m ² /s	ft ² /s
Phenylamine(41)	C ₆ H ₅ NO ₂	1.022	1,639	5,377.3	4.0	3.63	39.058
Phenyl bromide(46)	C ₆ H ₅ Br	1.522	1,170 (20°C)	3,838.6 (68°F)		0.693	7.465
Phenyl chloride	C ₆ H ₅ Cl	1.106	1,273	4,176.5	3.6	0.722	7.768
Phenyl iodide(46)	C ₆ H ₅ I	1.823	1,114 (20°C)	3,654.9 (68°F)		0.954 (15°C)	10.265 (59°F)
Phenyl methane(16,52)	C ₇ H ₈	0.867 (20°C)	1,328 (20°C)	4,357 (68°F)	4.27	0.644	6.929
3-Phenylpropenal	C ₉ H ₈ O	1.112	1,554	5,098.4	3.2		
Phthalardione	C ₈ H ₄ O ₃		1,125 (152°C)	3,691 (306°F)			
Phthalic acid,anhydride	C ₈ H ₄ O ₃		1,125 (152°C)	3,691 (306°F)			
Phthalicanhydride	C ₈ H ₄ O ₃		1,125 (152°C)	3,691 (306°F)			
Pimelicketone	C ₆ H ₁₀ O	0.948	1,423	4,668.6	4.0		
Plexiglas,Lucite,Acrylic			2,651	8,698			
PolyterpeneResin		0.77	1,099.8 (190°C)	3,608.4 (374°F)		39,000	419,500
Potassium bromide(42)	KBr		1,169 (900°C)	3,835.3 (1652°F)	0.71	715CP (900°C)	7.693 (1652°F)
Potassium fluoride(42)	KF		1,792 (900°C)	5,879.3 (1652°F)	1.03		
Potassium iodide(42)	KI		958 (900°C)	3,231.6 (1652°F)	0.64		
Potassium nitrate(48)	KNO ₃	1.859 (352°C)	1,740.1 (352°C)	5,709 (666°F)	1.1	1.19 (327°C)	12.804 (621°F)
Propane(2,13) (-45°to-130°)	C ₃ H ₈	0.585 (-45°C)	1,003 (-45°C)	3,290.6 (-46°F)	5.7		
1,2,3-Propanetriol	C ₃ H ₈ O ₃	1.26	1,904	6,246.7	2.2	000757	

It continues in the following page

It comes from the previous page

Substance	Chemical Formula	All data given at 25°C (77°F) unless otherwise noted.					
		Specific Gravity	Sound Speed		v/°C m/s/°C	Kinematic Viscosity x10 ⁻⁶	
			m/s	ft/s		m ² /s	ft ² /s
2-Propanol(46)	C ₃ H ₈ O	0.785 (20°C)	1,170 (20°C)	3,838.6 (68°F)		2.718	29.245
2-Propanone	C ₃ H ₆ O	0.791	1,174	3,851.7	4.5	0.399	4.293
Propene(17,18,35)	C ₃ H ₆	0.563 (-13°C)	963 (-13°C)	3,159.4 (9°F)	6.32		
N-propyl-acetate(22)	C ₅ H ₁₀ O ₂		1,280 (2°C)	4,199 (36°F)	4.63		
n-propyl-alcohol	C ₃ H ₈ O	0.78 (20°C)	1,222 (20°C)	4,009.2 (68°F)		2.549	27.427
propylchloride(47)	C ₃ H ₇ Cl	0.892	1,058	3,471.1		0.378	4.067
propylene(17,18,35)	C ₃ H ₆	0.536 (-13°C)	963 (-13°C)	3,159.4 (9°F)	6.32		
Pyridne	C ₆ H ₅ N	0.982	1,415	4,642.4	4.1	0.992 (20°)	10.673 (68°F)
Refrigerant11(3,4)	CCl ₃ F	1.49	828.3 (0°C)	2,717.5 (32°F)	3.56		
Refrigerant12(3)	CCl ₂ F ₂	1.516 (-40°C)	774.1 (-40°C)	2,539.7 (-40°F)	4.24		
Refrigerant14(14)	CF ₄	1.75 (-150°C)	875.24 (-150°C)	2,871.5 (-238°F)	6.61		
Refrigerant21(3)	CHCl ₂ F	1.426 (0°C)	891 (0°C)	2,923.2 (32°F)	3.97		
Refrigerant22(3)	CHClF ₂	1.491 (-69°C)	893.9 (50°C)	2,932.7 (122°F)	4.79		
Refrigerant113(3)	CCl ₂ F-CClF ₂	1.563	783.7 (0°C)	2,571.2 (32°F)	3.44		
Refrigerant114(3)	CClF ₂ -CClF ₂	1.455	665.3 (-10°C)	2,182.7 (14°F)	3.73		
Refrigerant115(3)	C ₂ ClF ₅		656.4 (-50°C)	2,153.5 (-58°F)	4.42		
RefrigerantC318(3)	C ₄ F ₈	1.62 (-20°C)	574 (-10°C)	1,883.2 (41°F)	3.88		
Selenium(8)	Se		1,072 (250°C)	3,517.1 (482°F)	0.68		

It continues in the following page

EUROSONIC 2000 HH

It comes from the previous page

Substance	Chemical Formula	All data given at 25°C (77°F) unless otherwise noted.					
		Specific Gravity	Sound Speed		v/°C m/s/°C	Kinematic Viscosity x10 ⁻⁶	
			m/s	ft/s		m ² /s	ft ² /s
Silicone(30cp)		0.993	990	3,248		30	322.8
Sodiumfluoride(42)	NaF	0.877	2,082 (1000°C)	6,830.7 (1832°F)	1.32		
Sodiumfluoride(48)	NaNO ₃	1.884 (336°C)	1,763.3 (336°C)	5,785.1 (637°F)	0.74	1.37 (336°C)	14.74 (637 °F)
Sodiumfluoride(48)	NaNO ₂	1.805 (292°C)	1,876.8 (292°C)	6,157.5 (558°F)			
Solvesso#3		0.877	1,370	4,494.8	3.7		
Spiritofwine	C ₂ H ₆ O	0.789	1,207	3,960	4.0	1.397	15.02
Sulfur(7,8,10)	S		1,177 (250°C)	3,861.5 (482°F)	-1.13		
SulfueicAcid(1)	H ₂ SO ₄	1.841	1,257.6	4,126	1.43	11.16	120.081
Tellurium(7)	Te		991 (450°C)	3,251.3 (842°F)	0.73		
1,1,2,2-Tetrabromoethane(47)	C ₂ H ₂ Br ₄	2.966	1,027	3,369.4			
1,1,2,2-Tetrachloroethane(67)	C ₂ H ₂ Cl ₄	1.595	1,147	3,763.4		1.156 (15°C)	12.438 (59°F)
Tetrachloroethane(46)	C ₂ H ₂ Cl ₄	1.553 (20°C)	1,170 (20°C)	3,838.6 (68°F)		1.19	12.804
Tetrachloro-ethene(47)	C ₂ Cl ₄	1.632	1,036	3,399			
Tetrachlor-Methane(33,47)	CCl ₄	1.595 (20°C)	926	3,038.1		0.607	6.531
Tetradecane(46)	C ₁₄ H ₃₀	0.763 (20°C)	1,331 (20°C)	4,366.8 (68°F)		2.86 (20°C)	30.773 (68°F)
Tetraethylene glycol	C ₈ H ₁₈ O ₅	1.123	1,568	5,203.4	3.0		
Tetrafluoro-methane(14)(Freon14)	CF ₄	1.75 (-150°C)	875.24 (-150°C)	2,871.5 (-238°F)	6.61		
Tetrahydro-1,4-isoxazine	C ₄ H ₈ NO	1.000	1,442	4,731	3.8		

It continues in the following page

It comes from the previous page

Substance	Chemical Formula	All data given at 25°C (77°F) unless otherwise noted.					
		Specific Gravity	Sound Speed		v/°C m/s/°C	Kinematic Viscosity x10 ⁻⁶	
			m/s	ft/s		m ² /s	ft ² /s
Toluene(16,52)	C ₇ H ₈	0.867 (20°C)	1,328 (20°C)	4,357 (68°F)	4.27	0.644	6.929
o-Toluidine(46)	C ₇ H ₉ N	0.999 (20°C)	1,618	5,308.4		4.394 (20°C)	47.279 (68°F)
p-Toluidine(46)	C ₇ H ₉ N	0.966 (45°C)	1,480	4,855.6		1.863 (50°C)	20.053 (122°F)
Toluol	C ₇ H ₈	0.866	1,308	4,291.3	4.2	0.58	6.24
Tribromo-methane(46,47)	CHBr ₃	2.89 (20°C)	918	3,011.8		0.645	7.037
1,1,1-Trichloro-ethane(47)	C ₂ H ₃ Cl ₃	1.33	985	3,231.6		0.902 (20°C)	9.705 (68°F)
Trichloro-ethene(47)	C ₂ HCl ₃	1.464	1,028	3,372.7			
Trichloro-fluoromethaen (3)(Freon11)	CCl ₃ F	1.49	828.3 (0°C)	2,171.5 (32°F)	3.56		
Trichloro-methane(47)	CHCl ₃	1.489	979	3,211.9	3.4	0.55	5.918
1,1,2-Trichloro-1,2,2,2-Trifluoro-Etham	CCl ₂ F-CClF ₂	1.563	783.7 (0°C)	2,571.2 (32°F)			
Triethyl-amine(33)	C ₆ H ₁₅ N	0.726	1,123	3,684.4	4.47		
Triethyleneglycol	C ₆ H ₁₄ O ₄	1.123	1,608	5,275.6	3.8		
1,1,1-Trifluoro-2-Chloro-2-Bromo-Ethane	C ₂ HClBrF ₃	1.869	693	2,273.6			
1,2,2-Trifluorotrichloro-ethane(Freon113)	CCl ₂ -CClF ₂	1.563	783.7 (0°C)	2,571.2 (32°F)	3.44		
d-1,3,3-Trimethylnorcamphor	C ₁₀ H ₁₆ O	0.947	1,320	4,330.7		0.22	2.367
Trinitrotoluene(43)	C ₇ H ₅ (NO ₂) ₃	1.64	1,610 (81°C)	5,282.2 (178°F)			
Turpentine		0.88	1,255	4,117.5		1.4	15.064
Unisis800		0.87	1,346	4,416		1.00	

It continues in the following page

EUROSONIC 2000 HH

It comes from the previous page

Substance	Chemical Formula	All data given at 25°C (77°F) unless otherwise noted.					
		Specific Gravity	Sound Speed		v/°C m/s/°C	Kinematic Viscosity x10 ⁻⁶	
			m/s	ft/s		m ² /s	ft ² /s
Water, distilled(49,50)	H ₂ O	0.996	1,498	4,914.7	-2.4	0.695	10.76
Water, sea							
WoodAlcihol(40,41)	D ₂ O		1,400	4,593	-2.4		
Xenon(45)		1.025	1,531	5,023	2.92	1.00	10.76
m-Xylene(46)	CH ₄ O	0.791 (20°C)	1,076	3,530.2		0.695	7.478
o-Xylene(29,46)	Xe		630 (-109°C)	2,067 (-164°F)			
P-xylene(46)	C ₈ H ₁₀	0.868 (15°C)	1,343 (20°C)	4,406.2 (68°F)		0.749 (15°C)	8.059 (59°F)
Xylenehexafluoride	C ₈ H ₁₀	0.897 (20°C)	1,331.5	4,368.4	4.1	0.903 (20°C)	9.716 (68°F)
Zinc(7)	C ₈ H ₁₀		1,334 (20°C)	4,376.6 (68°F)		0.662	7.123
1,1,1-Trifluoro-2-Chloro-2-Bromo-Ethane	C ₈ H ₄ F ₆	1.37	879	2,883.9		0.613	6.595
1,2,2-Trifluorotrichloro-ethane(Freon113)	Zn		3,298 (450°C)	10,820.2 (842°F)			



Euromag International SRL

Via Torino 3-35035 - Mestrino

PADOVA - ITALY

Tel. +39/049.9005064

Fax. +39/049.9007764

Mail. euromag@euromag.com

<http://www.euromag.com>